

PRELIMINARY GEOTECHNICAL ENGINEERING REPORT

**147 Spadina Ave.
Toronto, Ontario**

PREPARED FOR:
HM RB (147 Spadina) LP
474 Wellington Street West, Suite 200
Toronto, ON M5V 1E3

ATTENTION:
Charles Arbez

Grounded Engineering Inc.
File No. 21-019 (REV 1)
Issued August 18, 2021



TABLE OF CONTENTS

1	INTRODUCTION	4
2	GROUND CONDITIONS	5
2.1	SOIL STRATIGRAPHY.....	5
2.1.1	Surficial and Earth Fill.....	5
2.1.2	Sunnybrook Till	6
2.1.3	Don Beds.....	6
2.1.4	York Till	6
2.1.5	Bedrock.....	6
2.2	GROUNDWATER.....	9
2.3	CORROSIVITY AND SULPHATE ATTACK	9
2.4	LEACHATE ANALYSIS.....	11
3	GEOTECHNICAL ENGINEERING RECOMMENDATIONS.....	11
3.1	FOUNDATION DESIGN PARAMETERS	11
3.2	EARTHQUAKE DESIGN PARAMETERS	12
3.3	EARTH PRESSURE DESIGN PARAMETERS	13
3.4	SLAB ON GRADE DESIGN PARAMETERS	14
3.5	LONG-TERM GROUNDWATER AND SEEPAGE CONTROL	14
4	CONSIDERATIONS FOR CONSTRUCTION.....	15
4.1	EXCAVATIONS.....	15
4.2	SHORT-TERM GROUNDWATER CONTROL	17
4.3	EARTH-RETENTION SHORING SYSTEMS.....	18
4.3.1	Lateral Earth Pressure Distribution.....	18
4.3.2	Soldier Pile Toe Embedment.....	18
4.3.3	Lateral Bracing Elements	19
4.4	SITE WORK.....	19
4.5	ENGINEERING REVIEW.....	20
5	LIMITATIONS AND RESTRICTIONS	21
5.1	INVESTIGATION PROCEDURES	21
5.2	SITE AND SCOPE CHANGES	22
5.3	REPORT USE	22
6	CLOSURE.....	23



FIGURES

Figure 1 – Site Location Plan

Figure 2 – Borehole Location Plan (Existing)

Figure 3 – Borehole Location Plan (Proposed)

Figure 4 – Subsurface Cross-Section

APPENDICES

Appendix A – Borehole Logs; Abbreviations and Terminology

Appendix B – Geotechnical Laboratory Results

Appendix C – Rock Core Photographs

Appendix D – Boreholes by Others (Pinchin)

Appendix E – Laboratory Certificate of Chemical Analysis, Leachate and Corrosivity Parameters

Appendix F – Typical Details



1 Introduction

HM RB (147 Spadina) LP has retained Grounded Engineering Inc. (“Grounded”) to provide geotechnical engineering design advice for their proposed development at 147 Spadina Ave., in Toronto, Ontario.

The proposed project includes a new 25± storey building with three underground parking levels set at a lowest (P3) Finished Floor Elevation (FFE) of 79.0± m. The P3 underground parking structure is to be beneath the entire site. Spread footing foundations will be nominally 1 to 2 m lower.

Grounded has been provided with the following reports and drawings to assist in our geotechnical scope of work:

- Plan of Survey, prepared by KRCMAR (Nov 3, 2016).
- Audax Architecture Inc., “147 Spadina Ave, Toronto, Ontario”; Project 20-006, dated August 10, 2021 (Architectural Plans).
- Logs of Boreholes (final), “147 Spadina Avenue, Toronto Ontario”; Project # 282626.003, received July 22, 2021, prepared by Pinchin Ltd.

Grounded has been provided with borehole and monitoring well information from another consultant as listed above. The borehole logs are not provided in a report signed and sealed by professional engineers. Unless noted, borehole labels appended with “P-” refer to Pinchin’s boreholes. Pinchin monitoring well depths were verified by Grounded and are used solely for the purposes of groundwater monitoring at the subject site. The borehole information is appended.

Grounded’s subsurface investigation of the site to date includes five (5) boreholes (Boreholes 1 to 5) which were advanced from February 16th to April 9th, 2021.

Based on the borehole findings, preliminary geotechnical engineering advice for the proposed development is provided for foundations, seismic site classification, earth pressure design, slab on grade design, basement drainage, and pavement design. Construction considerations including excavation, groundwater control, and geostructural engineering design advice are also provided.

This preliminary geotechnical engineering report is appropriate for due diligence and planning purposes only. Additional boreholes, wells, and a detailed geotechnical engineering report will be required for detailed design.



2 Ground Conditions

The borehole results are detailed on the attached borehole logs. Our assessment of the relevant stratigraphic units is intended to highlight the strata as they relate to geotechnical engineering. The ground conditions reported here will vary between and beyond the borehole locations.

The stratigraphic boundary lines shown on the borehole logs are assessed from non-continuous samples supplemented by drilling observations. These stratigraphic boundary lines represent transitions between soil types and should be regarded as approximate and gradual. They are not exact points of stratigraphic change.

Elevations are measured relative to geodetic datum (CGVD28:PRE78). The horizontal coordinates are provided relative to the Universal Transverse Mercator (UTM) geographic coordinate system.

Asphalt and aggregate thicknesses reported here are observed in individual borehole locations through the top of the open borehole. Thicknesses may vary between and beyond the boreholes.

2.1 Soil Stratigraphy

The following soil stratigraphy summary is based on the borehole results and the geotechnical laboratory testing.

A cross-section showing stratigraphy and engineering units is appended and includes the relevant borehole and well information from the other consultants. Pinchin's wells were used for groundwater levels only.

2.1.1 Surficial and Earth Fill

Boreholes 1 to 4 are exterior boreholes and encountered a 75 to 300 mm thick asphalt pavement structure. No aggregate layer was observed in the boreholes.

Underlying the surficial materials, boreholes 1 to 4 observed a layer of earth fill that extends to depths of 0.8 to 1.5 metres below grade (Elev. 89.8 to 89.4 m). The earth fill varies in composition ranges from a clayey silt to a sandy silt soil. This material contains asphalt, brick, and construction debris. The earth fill at this site can be dark to medium brown, black, and grey, and moist to wet. Due to inconsistent placement and the inherent heterogeneity of earth fill materials, the relative density of the earth fill varies but is on average loose.

Borehole 5 is an interior borehole and encountered 100 mm of brick floor slab. No aggregate layer was observed in the borehole. A void space was discovered under the floor slab. Borehole 5 was terminated at 0.4 metres below grade due to unsupported floor slab, leading to unsafe drilling conditions.



2.1.2 Sunnybrook Till

Underlying the fill materials, boreholes 1 to 4 encounter an undisturbed native glacial till deposit with a matrix of cohesive silts (clayey silt to clayey sandy silt). These soils are grouped together as the “Sunnybrook Till”. This unit was encountered at 0.8 to 1.5 metres below grade (Elev. 89.8 to 89.4 m) and extends down to depths of 4.6 to 7.6 m below grade (Elev. 86.0 to 82.6 m). The upper till is generally brown to grey, and moist to wet.

Standard Penetration Test (SPT) results (N-Values) measured in the earth fill range from 3 to 33 blows per 300 mm of penetration (“bpf”), indicating a relative density ranging from soft to hard (on average, stiff).

2.1.3 Don Beds

Underlying the Sunnybrook Till, Boreholes 1 to 4 encounter an undisturbed native interglacial deposit with a matrix of cohesive clayey silts with coarse sand and gravel seams. These soils are grouped together as the “Don Beds”. This unit was encountered at 4.6 to 7.6 m below grade (Elev. 86.0 to 82.6 m) and extends down to a depth of 9.1 m below grade (Elev. 81.5 to 81.1 m).

The Don Beds are generally grey and moist. SPT N-values measured in this unit range from 19 to 62 bpf (on average hard).

2.1.4 York Till

Underlying the Don Beds, boreholes 1 to 4 encounter an undisturbed native glacial till deposit with a matrix of broadly cohesive silts and clays. These soils are grouped together as the “York Till”. This unit was encountered at a depth of 9.1 m below grade (Elev. 81.5 to 81.1 m) and extends down to depths of 12.2 to 13.7 m below grade (Elev. 78.4 to 76.6 m).

The York Till is generally grey and moist. SPT N-values measured in this unit range from 30 to 86 bpf (on average hard).

2.1.5 Bedrock

Inferred bedrock was encountered in boreholes 2 to 4 underlying the York Till at depths of 12.2 to 12.7 m below grade (Elev. 78.4 to 77.6 m). Bedrock was confirmed by rock cores recovered in Boreholes 2 and 4 to a depth of 13.0 m below grade (Elev. 77.6 and 77.2 m, respectively).

Detailed core logs are included with the corresponding borehole logs. Photographs of the recovered rock core and a guide of rock core terminology are appended. The rock core terminology sheet defines many of the descriptive terms used below.

The bedrock beneath the site is the Georgian Bay Formation, which comprises thin to medium bedded grey shale and limestone of Ordovician age. The shale is interbedded with calcareous shale, limestone, dolostone, and calcareous sandstone (conventionally grouped together as



“limestone”) which are typically laterally discontinuous. Per the appended terminology, the Georgian Bay shale is typically classified as “weak” whereas the limestone interbedding is classified as “strong”. The percentage of strong limestone beds in each run is reported on the rock core logs. The overall percentage of limestone found in Boreholes 2 and 4 was 19% and 20%, respectively.

A summary of the engineering properties of the Georgian Bay Formation is presented in the Ontario Ministry of Transportation and Communications document RR229, *Evaluation of Shales for Construction Projects* (March 1983). The relevant parameters from that document are as follows:

Table 2.1 – Summary of MTO Georgian Bay Formation Parameters

	Uniaxial Compressive Strength (MPa)	Young’s Modulus (GPa)	Dynamic Modulus (GPa)	Poisson’s Ratio
Average	28	4	19	0.19
Range	8 to 41	0.5 to 12	6 to 38	0.1 to 0.25

Directly below the overburden soils, the uppermost portion of bedrock is typically weathered. The MTO (Ontario Ministry of Transportation and Communications document RR229, *Evaluation of Shales for Construction Projects*) provides a *typical weathering profile of a low durability shale* reproduced from Skempton, Davis, and Chandler, which characterizes weathered versus unweathered shale as follows:

Table 2.2 – Typical Weathering Profile of a Low Durability Shale

	Zone	Description	Notes
Fully Weathered	IVb	Soil-like matrix only	indistinguishable from glacial drift deposits, slightly clayey, may be fissured
Partially Weathered	IVa	Soil-like matrix with occasional pellets of shale less than 3 mm dia.	little or no trace of rock structure, although matrix may contain relic fissures
	III	Soil-like matrix with frequent angular shale particles up to 25 mm dia.	moisture content of matrix greater than the shale particles
	II	angular blocks of unweathered shale with virtually no matrix separated by weaker chemically weathered but intact shale	spheroidal chemical weathering of shale pieces emanating from relic joints and fissures, and bedding planes
Unweathered (Sound)	I	shale	regular fissuring

In glacial till overburden soils directly overlying bedrock, a zone of till with fragmented shale is often observed and interpreted as either the lowest portion of the till, or as partially weathered Zone III rock. This interpretation is subjective and depends on the investigator. There is occasionally a concentration of boulders in the soil just above the bedrock that can be mistakenly identified as bedrock where rock coring is not performed. Weathering Zones III and IV are



frequently not present due to glacial scouring action, which often removes these zones from the bedrock surface.

The bedrock surface as indicated on the Borehole Logs from this investigation is intended to be consistently interpreted as the surface of Zone II. Based on examination of the rock cores from this site, the partially weathered rock (Zone II) is approximately 0.8 metres thick at the location of Borehole 2 and 4 and approximately 0.7 metres at Borehole 3. Weathered and sound bedrock elevations are summarized as follows:

Table 2.3 – Summary of Weathered and Sound Bedrock Elevations

Borehole	Ground Surface Elevation (m)	Partially Weathered (Zone II) Bedrock		Unweathered/Sound (Zone I) Bedrock	
		Depth (m)	Elevation (m)	Depth (m)	Elevation (m)
2	90.6	12.2	78.4	13.1	77.5
3	90.3	12.6	77.7	n/a	n/a
4	90.2	12.2	78.0	13.1	77.1

Rock Quality Designation (RQD) is an index measurement that refers to the total length of pieces of sound core in a core run that are at least 100 mm in length, expressed as a percentage of the total length of that core run. Only natural discontinuities are used in assessing RQD. The RQD of the recovered rock cores varied was typically 0% in the weathered bedrock and varies between 22% and 84% in the sound bedrock.

RQD underrepresents the competency of the Georgian Bay Formation and is not appropriate for horizontally bedded fissile shale. In this formation, the RQD is typically low due to the fissility of the shale as well as the closely spaced horizontal bedding planes. Our results are typical of this formation.

There are near-vertical joint sets within this shale that are typically very widely spaced at over 2 m apart. There are also several faults typically referred to as “shear zones” found within the formation, which are observed as zones of rock rubble within the cores. These faults defy discovery in conventional vertical boreholes.

The jointing and crush zones in the rock are related to the state of stress in the deposit. Research in the Greater Toronto Area has revealed that the bedrock contains locked-in horizontal stresses that could be remnants of the foreshortening that occurred in the earth’s crust during continental glaciation several thousand years ago. Documented experiments have indicated that the major principal stress is of the order of 2 MPa in the upper 1 to 2 metres of the deposit where the rock is weathered and contains more fractures. Intact rock can have an internal major principal stress as high as 4 to 5 MPa. The major and minor principal stresses are horizontal and may be oriented in any direction. The empirical approach to vertical stress below the top of bedrock is to use a uniform pressure distribution below the top of bedrock elevation that is equal to the maximum earth pressure calculated for the lowest level of soil in the profile.

The Georgian Bay Formation has been known to issue gases when penetrated. There are instances where both methane and hydrogen sulphide gas emissions have been detected in



excavations made in the Georgian Bay Formation. While there was no specific indication of gas emissions from the boreholes made in this investigation, the potential for gas emissions from this formation is recognized as a design issue to be addressed.

2.2 Groundwater

On completion of drilling, the boreholes were filled with drill fluid (from mud rotary drilling) and measuring the unstabilized groundwater level after drilling was not practical. Monitoring wells were installed in Boreholes 1 to 4, and stabilized groundwater levels were measured in each of the monitoring wells one week after the completion of drilling. The groundwater observations are shown on the Borehole Logs and are summarized as follows.

Table 2.4 – Summary of Groundwater Observations

Borehole No.	Borehole depth (m)	Upon completion of drilling		Strata Screened	Latest Water Level Reading April 16, 2021	
		Depth to cave (m)	Unstabilized water level (m)		Depth (m)	Elev. (m)
1	12.65	n/a	Filled with drill water	York Till	10.6	79.7
2	16.86	n/a	Filled with drill water	York Till	6.8	83.8
3	14.4	n/a	Filled with drill water	York Till / Weathered Bedrock	7.5	82.8
4	16.21	n/a	Filled with drill water	Bedrock	15.0	75.2

For preliminary basement wall design purposes, the groundwater table is approximately 3.8 metres below grade (approximate Elev. 86.5 m), in the clayey silt deposit of the Sunnybrook Till. This deposit has a low permeability and will yield only minor seepage in the long term. There is also water within discrete fractures in the bedrock, and perched infiltrated stormwater in the earth fill.

Groundwater levels fluctuate with time depending on the amount of precipitation and surface runoff and may be influenced by known or unknown dewatering activities at nearby sites.

Historically the Don Beds constituted a confined aquifer with significant piezometric head. As development has progressed in the downtown area over the last 30 years more and more drained structures have been made that penetrate this permeable deposit, the piezometric head in this deposit has lowered as it has become partially drained. Our boreholes at this site found the Don Beds in a moist to wet condition.

Grounded has prepared a preliminary hydrogeological report for this site (File No. 21-019).

2.3 Corrosivity and Sulphate Attack

Three (3) soil samples were submitted for corrosivity testing parameters (pH, Resistivity, Electrical Conductivity, Redox Potential, Sulphate, Sulphide and Chloride). The Certificate of Analyses is appended.



The soil samples were analysed for soluble sulphate concentration and compared to the Canadian Standard CAN3/CSA A23.1-M94 Table 3, *Additional Requirements for Concrete Subjected to Sulphate Attack*. The results are summarized as follows:

Table 2.5 – Soluble Sulphate Concentration Results

Parameter	BH 2 SS 2B	BH 3 SS 3	BH 4 SS 2
Soluble Sulphate (SO ₄) in soil sample	35 µg/g < 0.1 %	34 µg/g < 0.1 %	47 µg/g < 0.1 %
Class of Exposure	Negligible	Negligible	Negligible

Corrosivity parameters are also used for assessing soil corrosivity applicable to cast iron alloys, according to the 10-point soil evaluation procedure described in the American Water Work Association (AWWA) C-105 standard. The results are summarized as follows:

Table 2.6 - Corrosivity Results and Assigned Points Based on AWWA C-105 Standard

Parameter	AWWA C-105 Standard – Assigned Points					
	BH 2 SS 2B		BH 3 SS 3		BH 4 SS 2	
	Result	Points	Result	Points	Result	Points
Resistivity (ohm.cm)	2930	0	3440	0	598	10
pH	8.26	0	8.52	3	8.36	0
Redox Potential (mV)	180	0	204	0	259	0
Sulfides (%)	< 0.04	2	< 0.04	2	< 0.04	2
Moisture (%)	18.4	2	12.7	2	13.8	2
Corrosion protection recommended?	No		No		Yes	
Resistivity less than 2000 ohm.cm?	No		No		Yes	

The analytical results only provide an indication of the potential for corrosion. Samples from Borehole 2 and 3 scored less than 10 points and corrosion protective measures are therefore not recommended for cast iron alloys. Sample BH4–SS2 scored greater than 10 points and corrosion protective measures are therefore recommended for cast iron alloys. A more recent study by the AWWA has suggested that soil with a resistivity of less than about 2000 ohm.cm should be considered aggressive. Sample BH4–SS2 had resistivity measurements less than 2000 ohm.cm and is therefore considered aggressive.



2.4 Leachate Analysis

In addition to the O.Reg. 153/04 analysis noted above, one (1) sample was submitted for analysis of O.Reg. 347 Schedule 4 parameters (TCLP analysis) for waste classification purposes. The analysis was conducted for the following parameters:

- Benzo(a)pyrene
- Metals & Inorganics
- Volatile Organic Compounds (VOCs)
- Polychlorinated Biphenyls (PCBs)

The results of chemical analysis indicate that the soil is considered **non-hazardous** and should be handled as accordingly.

The laboratory Certificates of Analysis are enclosed.

3 Geotechnical Engineering Recommendations

Based on the factual data summarized above, preliminary geotechnical engineering recommendations are provided. These preliminary recommendations are for due diligence purposes only. They must be supplemented and confirmed by additional boreholes, wells, and a detailed geotechnical engineering report at the detailed design stage.

This report assumes that the design features relevant to the geotechnical analyses will be in accordance with applicable codes, standards, and guidelines of practice. If there are any changes to the site development features, or there is any additional information relevant to the interpretations made of the subsurface information with respect to the geotechnical analyses or other recommendations, then Grounded should be retained to review the implications of these changes with respect to the contents of this report.

3.1 Foundation Design Parameters

Foundations made at the proposed P3 lowest FFE (Elev. 79.0 m) may be made as spread footings (made as conventional cast in place footings or drilled piers) made to bear on weathered bedrock (Elev. 78.4 m at BH2, Elev. 77.6 m at BH3, and Elev. 78.0 m at BH4). These foundations may be designed using a maximum factored geotechnical resistance at ULS of 5,000 kPa. The net geotechnical reaction at SLS is 3,000 kPa, for an estimated total settlement of 25 mm.

Higher capacity foundations may also be made as conventional spread footings or drilled piers bearing on sound bedrock (Elev. 77.6 m at BH2 and Elev. 77.2 m at BH4). Conventional spread footings or drilled piers made to bear on sound bedrock of the Georgian Bay Formation may be designed using a maximum factored geotechnical resistance at ULS of 10,000 kPa. The net geotechnical reaction at SLS is 6,000 kPa, for an estimated total settlement of 25 mm.



Spread footing or drilled pile foundations must be at least 1000 mm wide and must be embedded as specified above by the top elevation of each bearing layer. These minimum requirements apply in conjunction with the above recommended geotechnical resistance regardless of loading considerations. The geotechnical reaction at SLS refers to a settlement which for practical purposes is linear and non-recoverable. Differential settlement is related to column spacing, column loads, and footing sizes.

Footings stepped from one level to another should be at a slope not exceeding 1 vertical to 1 horizontal for the above bearing pressures to be applicable. There must be a minimum of 300 mm between the edge of any footing and the top of a sloped 2V:1H sound rock cut down to another footing.

The lowest levels of unheated underground parking structures two or more levels deep are, although unheated, still warmer than typical outdoor winter temperatures in the Greater Toronto Area. Interior foundations (or pile caps) with 900 mm of frost cover perform adequately, as do perimeter foundations with 600 mm of frost cover. Where foundations are next to ventilation shafts or are exposed to typical outdoor temperatures, 1.2 m of earth cover (or equivalent insulation) is required for frost protection.

The founding subgrade must be cleaned of all unacceptable materials and approved by Grounded prior to pouring concrete for the footings. Such unacceptable materials may include disturbed or caved soils, ponded water, or similar as indicated by Grounded during founding subgrade inspection. During the winter, adequate temporary frost protection for the footing bases and concrete must be provided if construction proceeds during freezing weather conditions. The bedrock surface can weather and deteriorate on exposure to the atmosphere or surface water; hence, foundation bases which remain open for an extended period of time should be protected by a skim coat of lean concrete.

3.2 Earthquake Design Parameters

The Ontario Building Code (2012) stipulates the methodology for earthquake design analysis, as set out in Subsection 4.1.8.7. The determination of the type of analysis is predicated on the importance of the structure, the spectral response acceleration, and the site classification.

The parameters for determination of Site Classification for Seismic Site Response are set out in Table 4.1.8.4A of the Ontario Building Code (2012). The classification is based on the determination of the average shear wave velocity in the top 30 metres of the site stratigraphy, where shear wave velocity (v_s) measurements have been taken. Alternatively, the classification is estimated from the rational analysis of undrained shear strength (s_u) or penetration resistance (N-values) according to the OBC and National Building Code of Canada.

Below the nominal founding elevations, the boreholes observe weathered bedrock and there will be less than 3 m of soil between the top of bedrock and the base of grade beams, pile caps, or footings. Based on this information, the site designation for seismic analysis is **Class B**, per Table



4.1.8.4.A of the Ontario Building Code (2012). Tables 4.1.8.4.B and 4.1.8.4.C. of the same code provide the applicable acceleration- and velocity-based site coefficients.

3.3 Earth Pressure Design Parameters

At this site, the design parameters for structures subject to unbalanced earth pressures such as basement walls and retaining walls are shown in the following table.

Table 3.1 – Design Parameters for Structures Subject to Unbalanced Earth Pressures

Stratigraphic Unit	γ	ϕ	K_a	K_o	K_p
Compact Granular Fill Granular 'B' (OPSS.MUNI 1010)	21	32	0.31	0.47	3.25
Existing Earth Fill	19	29	0.35	0.52	2.88
Sunnybrook Till	22	30	0.33	0.50	3.00
Don Beds	21	38	0.24	0.38	4.20
York Till	22	30	0.33	0.50	3.00
Sound Bedrock	26	28	n/a		

- γ = soil bulk unit weight (kN/m³)
- ϕ = internal friction angle (degrees)
- K_a = active earth pressure coefficient (Rankine, dimensionless)
- K_o = at-rest earth pressure coefficient (Rankine, dimensionless)
- K_p = passive earth pressure coefficient (Rankine, dimensionless)

These earth pressure parameters assume that grade is horizontal behind the retaining structure. If retained grade is inclined, these parameters do not apply and must be re-evaluated.

The following equation can be used to calculate the unbalanced earth pressure imposed on walls:

$$P = K[\gamma(h - h_w) + \gamma' h_w + q] + \gamma_w h_w$$

- P = horizontal pressure (kPa) at depth h
- h = the depth at which P is calculated (m)
- K = earth pressure coefficient
- h_w = height of groundwater (m) above depth h
- γ = soil bulk unit weight (kN/m³)
- γ' = submerged soil unit weight ($\gamma - 9.8$ kN/m³)
- q = total surcharge load (kPa)

If the wall backfill is drained such that hydrostatic pressures on the wall are effectively eliminated, this equation simplifies to:

$$P = K[\gamma h + q]$$

Where walls are made directly against shoring, prefabricated composite drainage panel covering the blind side of the wall is used to provide drainage. Water from the composite drainage panel is collected and discharged through the basement wall in solid ports directly to the sumps. This is discussed in Section 3.5.



The possible effects of frost on retaining earth structures must be considered. In frost-susceptible soils, pressures induced by freezing pore water are basically irresistible. Insulation typically addresses this issue. Alternatively, non-frost-susceptible backfill may be specified.

Foundation resistance to sliding is proportional to the friction between the rock subgrade and the base of the footing. The factored geotechnical resistance to friction (R_f) at ULS provided in the following equation:

$$R_f = \Phi N \tan \varphi$$

R_f	=	frictional resistance (kN)
Φ	=	reduction factor per Canadian Foundation Engineering Manual (CFEM) Ed. 4 (0.8)
N	=	normal load at base of footing (kN)
φ	=	internal friction angle (see table above)

3.4 Slab on Grade Design Parameters

At the proposed lowest P3 elevation, the undisturbed native York Till will provide adequate subgrade for the support of a conventional slab on grade. The modulus of subgrade reaction for slab-on-grade design supported by undisturbed native soils is 40,000 kPa/m.

The slab on grade must be provided with a drainage layer and capillary moisture break, which is achieved by forming the slab on a minimum 200 mm thick layer of 19 mm clear stone (OPSS 1004) vibrated to a dense state.

The use of excavated bedrock spoil to restore subgrade elevations is to be specifically prohibited. This bedrock spoil cannot be adequately compacted to provide support for the slab on grade and is not to be reused below any settlement sensitive areas.

A permanent drainage system including subfloor drains is required (see Section 3.5).

3.5 Long-Term Groundwater and Seepage Control

To limit seepage to the extent practicable, exterior grades adjacent to foundation walls should be sloped at a minimum 2 percent gradient away from the wall for 1.2 m minimum. The exterior faces of foundation walls should be provided with a layer of waterproofing to protect interior finishes.

For a conventional drained basement approach, perimeter and subfloor drainage systems are required for the underground structure. Subfloor drainage collects and removes the seepage that infiltrates under the floor. Perimeter drainage collects and removes seepage that infiltrates at the foundation walls.

Subfloor drainage pipes are to be spaced at an average 6 m (measured on-centres). Subfloor drains are typically installed in trenches below the capillary moisture break drainage layer per the typical detail appended. If trenches are to be avoided for whatever reason, the subfloor drainage



system can be incorporated into the capillary moisture break and drainage layer. The subfloor drains are then laid directly on the flat subgrade and backfilled with a minimum 300 mm thick layer of 19 mm clear stone, vibrated to a dense state. Any solid collection pipes must be sloped so that they positively discharge to the sumps.

The walls of the substructure are to be fully drained to eliminate hydrostatic pressure. Where drained basement walls are made directly against shoring, prefabricated composite drainage panel covering the blind side of the wall is used to provide drainage. Seepage from the composite drainage panel is collected and discharged through the basement wall in solid ports directly to the sumps. A layer of waterproofing placed between the drain core product and the basement wall should be considered to protect interior finishes from moisture.

Typical basement drainage details are appended.

The perimeter and subfloor drainage systems are critical structural elements since they eliminate hydrostatic pressure from acting on the basement walls and floor slab. The sumps that ensure the performance of these systems must have a duplexed pump arrangement providing 100% redundancy, and they must be on emergency power. The sumps should be sized by the mechanical engineer to adequately accommodate the estimated volume of water seepage.

The permanent dewatering requirements are provided in Grounded's Preliminary Hydrogeological Report (File No. 21-019).

4 Considerations for Construction

4.1 Excavations

Excavations must be carried out in accordance with the *Occupational Health and Safety Act – Regulation 213/91 – Construction Projects (Part III - Excavations, Section 222 through 242)*. These regulations designate four (4) broad classifications of soils to stipulate appropriate measures for excavation safety. For practical purposes:

- The earth fill is a Type 3 soil;
- The Sunnybrook Till is a Type 2 soil;
- The Don Beds are Type 4 soils, or Type 3 soils if dewatered; and
- The York Till is a Type 2 soil.

In accordance with the regulation's requirements, the soil must be suitably sloped and/or braced where workmen must enter a trench or excavation deeper than 1.2 m. Safe excavation slopes by soil type are stipulated as follows:



Table 4.1 – Safe Excavation Slopes by Soil Type

Soil Type	Base of Slope	Steepest Slope Inclination
1	within 1.2 metres of bottom of trench	1 horizontal to 1 vertical
2	within 1.2 metres of bottom of trench	1 horizontal to 1 vertical
3	from bottom of trench	1 horizontal to 1 vertical
4	from bottom of trench	3 horizontal to 1 vertical

Minimum support system requirements for steeper excavations are stipulated in Sections 235 through 238 and 241 of the Act and Regulations and include provisions for timbering, shoring and moveable trench boxes.

Bedrock is not considered a soil under the Act. Vertical excavations made in sound bedrock are generally self-supporting provided the rock bedding is horizontally oriented. If deemed necessary, rock bolts can be used to anchor a layer of protective mesh that will protect workers from loose rock spalling from the face of excavation. The rock face must be inspected by Grounded to determine that no other support system is required to prevent the spalling of loose rock, and to confirm that all loose spall material at risk of falling upon a worker is removed (Section 233 of the above noted regulations).

Larger obstructions (e.g., buried concrete debris, other obstructions) not directly observed in the boreholes are likely present in the earth fill. Similarly, larger inclusions (e.g., cobbles and boulders) may be encountered in the native soils. The size and distribution of these obstructions cannot be predicted with boreholes, as the split spoon sampler is not large enough to capture particles of this size. Provision must be made in excavation contracts to allocate risks associated with the time spent and equipment utilized to remove or penetrate such obstructions when encountered.

Excavations will penetrate weathered and sound bedrock. Georgian Bay Formation bedrock is a rippable rock that can be removed with conventional excavation equipment once it has been broken by ripper tooth or hoe ram. Creating detailed excavation shapes for foundations etc. is normally accomplished by hoe ram. The removal of rock from a vertical face without over-excavation, which can happen inadvertently by dislodging additional rock, is largely dependent on machine operator skill. If excavation faces must be made neat (such as beside an existing footing), a line of excavation can be provided by line drilling the rock a series of closely spaced vertical holes (100 mm diameter, spaced at 300 mm on centre) to provide a preferential vertical break path for the excavation face.

Georgian Bay Formation bedrock contains beds of harder limestone. When excavating this bedrock, it should be expected that these beds will be encountered. Hard layers of limestone interbedded within the shale are normally broken with hoe mounted hydraulic rams before excavation.

Limestone beds may also be found to straddle the founding elevation, in which case the entire thickness of the hard limestone layer must be removed to expose founding subgrade as it is not possible to remove part of one of these layers. This will in turn result in excess rock removal not intrinsic to the project requirements. The risk and responsibility for the excess rock removal under these circumstances, and the supply and placement of the extra concrete to restore the



foundation grade, must be addressed in the contract documents for foundations, excavation, and shoring contractors.

4.2 Short-Term Groundwater Control

Considerations pertaining to groundwater discharge quantities and quality are discussed in Grounded's preliminary hydrogeological report for the site, under separate cover.

For design purposes, the stabilized groundwater table is at about Elev. 86.5±m. The water table is present in all the native soil units. The lowest (P3) FFE is at about Elev. 79.0 m. Therefore,

- Bulk excavation will extend below the elevation of the prevailing groundwater table;
- Foundation excavations will extend down to about 9 m below the prevailing groundwater table; and
- The foundation excavations will penetrate relatively low permeability native soils, which will yield little free-flowing water.

Positive dewatering to lower the groundwater table will be required to facilitate construction as well as to maintain the integrity of the subgrade for foundation and slab-on-grade support. Dewatering will take some time to accomplish prior to the start of excavation. The water level must be kept at least 1.2 m below the lowest excavation elevation during construction. Failure to dewater prior to excavation will result in unrecoverable disturbance of the subgrade, which will render advice provided for undisturbed subgrade conditions inapplicable. Dewatering of the bedrock is not required.

It is recommended that a professional dewatering contractor be consulted to review the subsurface conditions and to design a site-specific dewatering system. It is the dewatering contractor's responsibility to assess the factual data and to provide recommendations on dewatering system requirements.

Should the excavation be supported using permeable soldier pile and lagging shoring, positive dewatering will be required on a continuous ongoing basis during excavation and throughout construction.

Large precipitation events will create volumes of water which will then need to be pumped out of the excavation. This dewatering can be staged over the course of multiple days so as not to exceed the limit for water removal without an ESAR posting; otherwise, an ESAR posting can be obtained in advance of construction to avoid possible delays.

The City of Toronto will require Discharge Agreements in the short and long-terms, if any water is to be discharged to the storm or sanitary sewers. It should be noted that securing a permit to take water on a permanent basis may not be supported by regulatory agencies. If a permit to take water on a permanent basis is not feasible, all below-grade structures need to be designed as a fully waterproofed structure with no permanent dewatering.



4.3 Earth-Retention Shoring Systems

No excavation shall extend below the foundations of existing adjacent structures without adequate alternative support being provided. Underpinning guidelines are appended.

Excavations are to be supported using conventional soldier pile and lagging walls with active dewatering prior to and during construction. The shoring system must be designed to accommodate foundation excavations on weathered or sound bedrock in accordance with the bedrock depths provided in Section 2.1.5.

4.3.1 Lateral Earth Pressure Distribution

If the shoring is supported with a single level of earth anchor or bracing, a triangular earth pressure distribution like that used for the basement wall design is appropriate.

Where multiple rows of lateral supports are used to support the shoring walls, research has shown that a distributed pressure diagram more realistically approximates the earth pressure on a shoring system of this type, when restrained by pre-tensioned anchors. A multi-level supported shoring system can be designed based on an earth pressure distribution with a maximum pressure defined by:

$$P = 0.8 K[\gamma H + q] + \gamma_w h_w \dots \text{in cohesive soils}$$

- P = maximum horizontal pressure (kPa)
- K = earth pressure coefficient (see Section 3.3)
- H = total depth of the excavation (m)
- h_w = height of groundwater (m) above the base of excavation
- γ = soil bulk unit weight (kN/m³)
- q = total surcharge loading (kPa)

Where shoring walls are drained to effectively eliminate hydrostatic pressure on the shoring system (e.g., pile and lagging walls), h_w is equal to zero.

In cohesive soils, the lateral earth pressure distribution is trapezoidal, uniformly increasing from zero to the maximum pressure defined in the equation above over the top and bottom quarter (H/4) of the shoring.

4.3.2 Soldier Pile Toe Embedment

Soldier pile toes must be made in bedrock of the Georgian Bay Formation to allow for excavations for foundations in bedrock in accordance with the elevations provided in Section 2.1.5. Soldier pile toes resist horizontal movement due to the passive earth pressure acting on the toe below the base of excavation. The maximum factored vertical geotechnical resistance at ULS for the design of a pile embedded in the weathered bedrock is 5 MPa. The maximum factored lateral geotechnical resistance at ULS of the undisturbed rock is 0.5 MPa. The maximum factored vertical geotechnical resistance at ULS for the design of a pile embedded in the sound bedrock is



10 MPa. The maximum factored lateral geotechnical resistance at ULS of the undisturbed rock is 1 MPa.

4.3.3 Lateral Bracing Elements

The shoring system at this site will require lateral bracing. If feasible, the shoring system should be supported by pre-stressed soil anchors (tiebacks) extending into the subgrade of the adjacent properties. To limit the movement of the shoring system as much as is practically possible, tiebacks are installed and stressed as excavation proceeds. The use of tiebacks through adjacent properties requires the consent (through encroachment agreements) of the adjacent property owners.

Anchors made in the plastic till tend to creep over time and therefore, if possible, it is better to anchor in the bedrock. In the Sunnybrook Till, Don Beds and York Tills, it is expected that post-grouted anchors can be made such that an anchor will safely carry up to 50 kN/m of adhered anchor length (at a nominal borehole diameter of 150 mm). Conventional rock anchors made in Georgian Bay Formation bedrock can be designed using a working adhesion of 620 kPa.

At least one prototype anchor per tieback level must be performance-tested to 200% of the design load to demonstrate the anchor capacity and validate design assumptions. Given the potential variability in soil conditions or installation quality, all production anchors must also be proof tested to 133% of the design load.

The hard till below the proposed FFE is suitable for the placement of raker foundations. Raker footings established on hard soils at an inclination of 45 degrees can be designed for a maximum factored geotechnical resistance at ULS of 300 kPa.

The weathered bedrock below the proposed FFE is suitable for the placement of raker foundations. Raker footings established on weathered bedrock at an inclination of 45 degrees can be designed using a maximum factored geotechnical resistance at ULS of 1000 kPa.

4.4 Site Work

To better protect wet undisturbed subgrade, excavations exposing wet soils must be cut neat, inspected, and then immediately protected with a skim coat of concrete (i.e., a mud mat). Wet sands are susceptible to degradation and disturbance due to even mild site work, frost, weather, or a combination thereof.

The effects of work on site can greatly impact soil integrity. Care must be taken to prevent this damage. Site work carried out during periods of inclement weather may result in the subgrade becoming disturbed unless a granular working mat is placed to preserve the subgrade soils in their undisturbed condition. Subgrade preparation activities should not be conducted in wet weather and the project must be scheduled accordingly.



If site work causes disturbance to the subgrade, removal of the disturbed soils and the use of granular fill material for site restoration or underfloor fill will be required at additional cost to the project.

It is construction activity itself that often imparts the most severe loading conditions on the subgrade. Special provisions such as end dumping and forward spreading of earth and aggregate fills, restricted construction lanes, and half-loads during placement of the granular base and other work may be required, especially if construction is carried out during unfavourable weather.

Adequate temporary frost protection for the founding subgrade must be provided if construction proceeds in freezing weather conditions. The subgrade at this site is susceptible to frost damage. Depending on the project context, consideration should be given to frost effects (heaving, softening, etc.) on exposed subgrade surfaces.

The exposed Georgian Bay Formation deteriorates with time. Exposed excavation faces have been found to flake and recede as much as 300 mm with 12 months exposure. This recession generally takes the form of coin size shale particles dropping from the face on a constant basis. The deteriorated rock loses internal integrity and bearing capability. If bedrock is to be exposed for prolonged periods of time, it is recommended that a skim coat of concrete be used to protect the surface of bedrock from slaking and other degradation resulting from weathering.

4.5 Engineering Review

By issuing this preliminary report, Grounded Engineering has assumed the role of Geotechnical Engineer of Record for this site. Grounded should be retained to review the structural engineering drawings prior to issue or construction to ensure that the recommendations in this report have been appropriately implemented.

All foundation installations must be reviewed in the field by Grounded, the Geotechnical Engineer of Record, as they are constructed. The on-site review of the condition of the founding subgrade as the foundations are constructed is as much a part of the geotechnical engineering design function as the design itself; it is also required by Section 4.2.2.2 of the Ontario Building Code. If Grounded is not retained to carry out foundation engineering field review during construction, then Grounded accepts no responsibility for the performance or non-performance of the foundations, even if they are constructed in general conformance with the engineering design advice contained in this report.

The long-term performance of a slab on grade is highly dependent upon the subgrade support and drainage conditions. Strict procedures must be maintained during construction to maintain the integrity of the subgrade to the extent possible. The design advice in this report is based on an assessment of the subgrade support capabilities as indicated by the boreholes. These conditions may vary across the site depending on the final design grades and therefore, the preparation of the subgrade and the compaction of all fill should be monitored by Grounded at the time of construction to confirm material quality, thickness, and to ensure adequate compaction.



A visual pre-construction survey of adjacent lands and buildings is recommended to be completed prior to the start of any construction. This documents the baseline condition and can prevent unwarranted damage claims. Any shoring system, regardless of the execution and design, has the potential for movement. Small changes in stress or soil volume can cause cracking in adjacent buildings.

5 Limitations and Restrictions

Grounded should be retained to review the structural engineering drawings prior to issue or construction to ensure that the recommendations in this report have been appropriately implemented.

This preliminary geotechnical engineering study is intended for due diligence purposes only. At detailed design, site-specific boreholes, groundwater monitoring wells, and updated detailed geotechnical engineering advice are required. Once completed, the future detailed geotechnical engineering report by Grounded Engineering would then supersede this preliminary report.

5.1 Investigation Procedures

The geotechnical engineering analysis and preliminary advice provided are based on the factual borehole information observed and recorded by Grounded. The investigation methodology and engineering analysis methods used to carry out this scope of work are consistent with conventional standard practice by Grounded as well as other geotechnical consultants, working under similar conditions and constraints (time, financial and physical).

Borehole drilling services were provided to Grounded by a specialist professional contractor. The drilling was observed and recorded by Grounded's field supervisor on a full-time basis. Drilling was conducted using conventional drilling rigs equipped with hollow stem augers, mud rotary, and rock coring tooling. As drilling proceeded, groundwater observations were made in the boreholes. Based on examination of recovered borehole samples, our field supervisor made a record of borehole and drilling observations. The field samples were secured in air-tight clean jars and bags and taken to the Grounded soil laboratory where they were each logged and reviewed by the geotechnical engineering team and the senior reviewer.

The Split-Barrel Method technique (ASTM D1586) was used to obtain the soils samples. The sampling was conducted at conventional intervals and not continuously. As such, stratigraphic interpolation between samples is required and stratigraphic boundary lines do not represent exact depths of geological change. They should be taken as gradual transition zones between soil or rock types.

A carefully conducted, fully comprehensive investigation and sampling scope of work carried out under the most stringent level of oversight may still fail to detect certain ground conditions. As such, users of this report must be aware of the risks inherent in using engineered field



investigations to observe and record subsurface conditions. As a necessary requirement of working with discrete test locations, Grounded has assumed that the conditions between test locations are the same as the test locations themselves, for the purposes of providing geotechnical engineering advice.

It is not possible to design a field investigation with enough test locations that would provide complete subsurface information, nor is it possible to provide geotechnical engineering advice that completely identifies or quantifies every element that could affect construction, scheduling, or tendering. Contractors undertaking work based on this report (in whole or in part) must make their own determination of how they may be affected by the subsurface conditions, based on their own analysis of the factual information provided and based on their own means and methods. Contractors using this report must be aware of the risks implicit in using factual information at discrete test locations to infer subsurface conditions across the site and are directed to conduct their own investigations as needed.

5.2 Site and Scope Changes

Natural occurrences, the passage of time, local construction, and other human activity all have the potential to alter the subsurface conditions directly or indirectly at or near the project site. Contractual obligations related to groundwater or stormwater control, disturbed soils, frost protection, etc. must be considered with attention and care as they relate this potential site alteration.

This report provides preliminary geotechnical engineering advice intended for use by the owner and their retained design team for due diligence only. These preliminary interpretations, design parameters, advice, and discussion on construction considerations are not complete. A detailed site-specific geotechnical investigation must be conducted by Grounded during detailed design to confirm and update the preliminary recommendations provided here.

5.3 Report Use

The authorized users of this report are HM RB (147 Spadina) LP and their design team, for whom this report has been prepared. Grounded Engineering Inc. maintains the copyright and ownership of this document. Reproduction of this report in any format or medium requires explicit prior authorization from Grounded Engineering Inc.

The City of Toronto may also make use of and rely upon this report, subject to the limitations as stated.



6 Closure

If the design team has any questions regarding the discussion and advice provided, please do not hesitate to have them contact our office. We trust that this report meets your requirements at present.

For and on behalf of our team,



Katrina Morgenroth, EIT

Michael Diez de Aux, M.A.Sc., P.Geo., P.Eng.
Associate

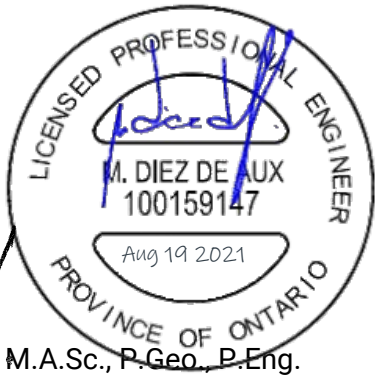

FIGURES





GROUND
ENGINEERING

12 Banigan Drive, Toronto, Ont., M4H 1E9
www.groundedeng.ca

LEGEND

— APPROXIMATE SITE LOCATION

Note

Reference

Survey Drawing job no. 16-223.
Certificate date: Nov 3, 2016. Prepared
by KRCMAR.

Project

**147 SPADINA AVENUE,
TORONTO, ONTARIO**

Figure Title

**SITE LOCATION
PLAN**

North

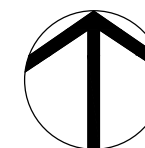

Date

AUGUST 2021

Scale

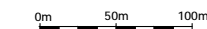

Job No



21-019

Figure No

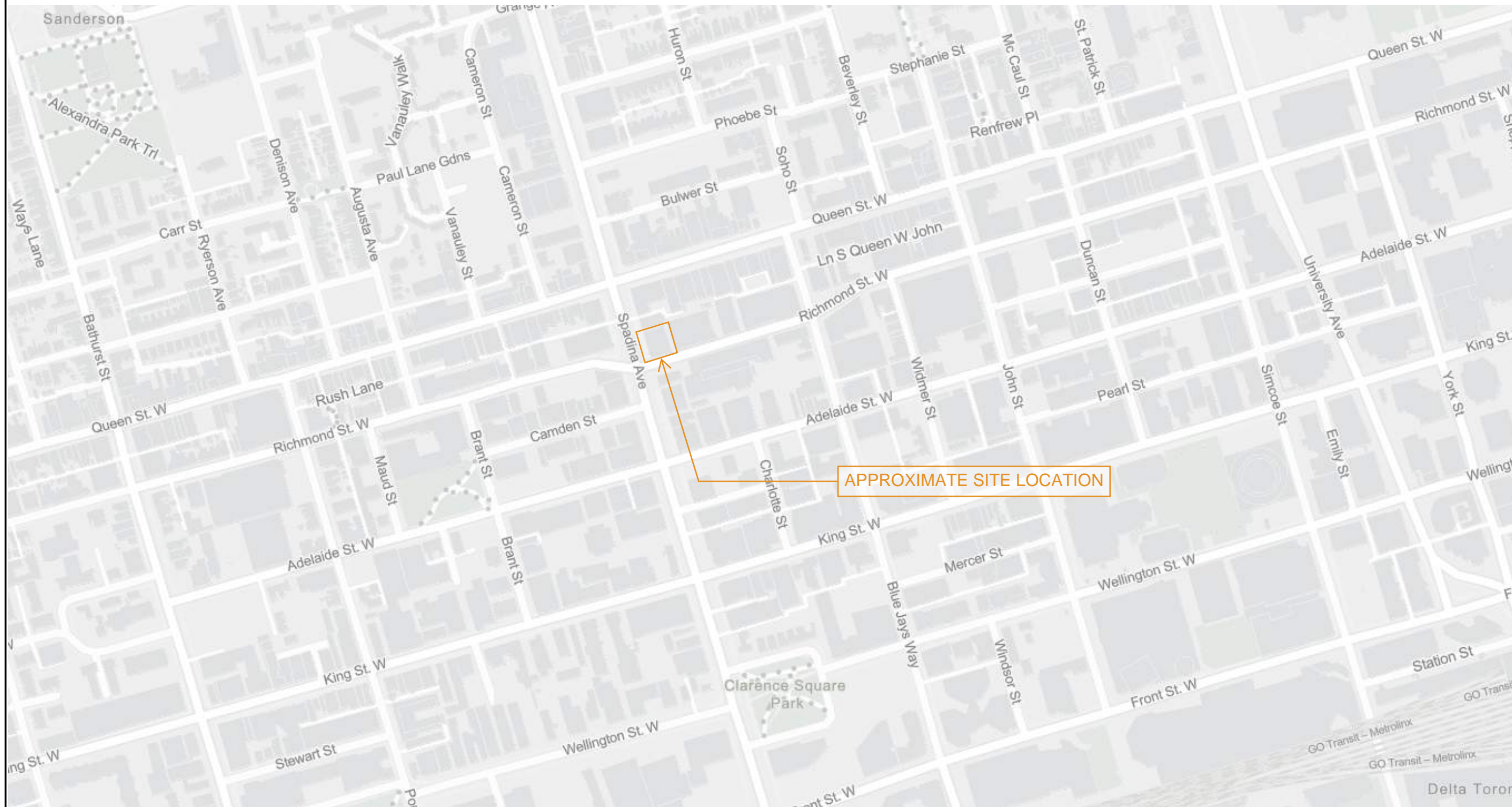
FIGURE 1



LEGEND

-  APPROXIMATE PROPERTY BOUNDARY
-  GROUNDING BOREHOLE / MONITORING WELL LOCATION
-  BOREHOLE LOCATION WITH MONITORING WELL BY OTHERS

Note

Reference

Survey Drawing job no. 16-223.
Certificate date: Nov 3, 2016. Prepared by KRCMAR.

Project

**147 SPADINA AVENUE,
TORONTO, ONTARIO**

Figure Title

**BOREHOLE AND
MONITORING WELL
LOCATION PLAN (Existing)**

North

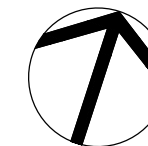

Date

JULY 2021

Scale

AS INDICATED

Job No

21-019

Figure No

FIGURE 2

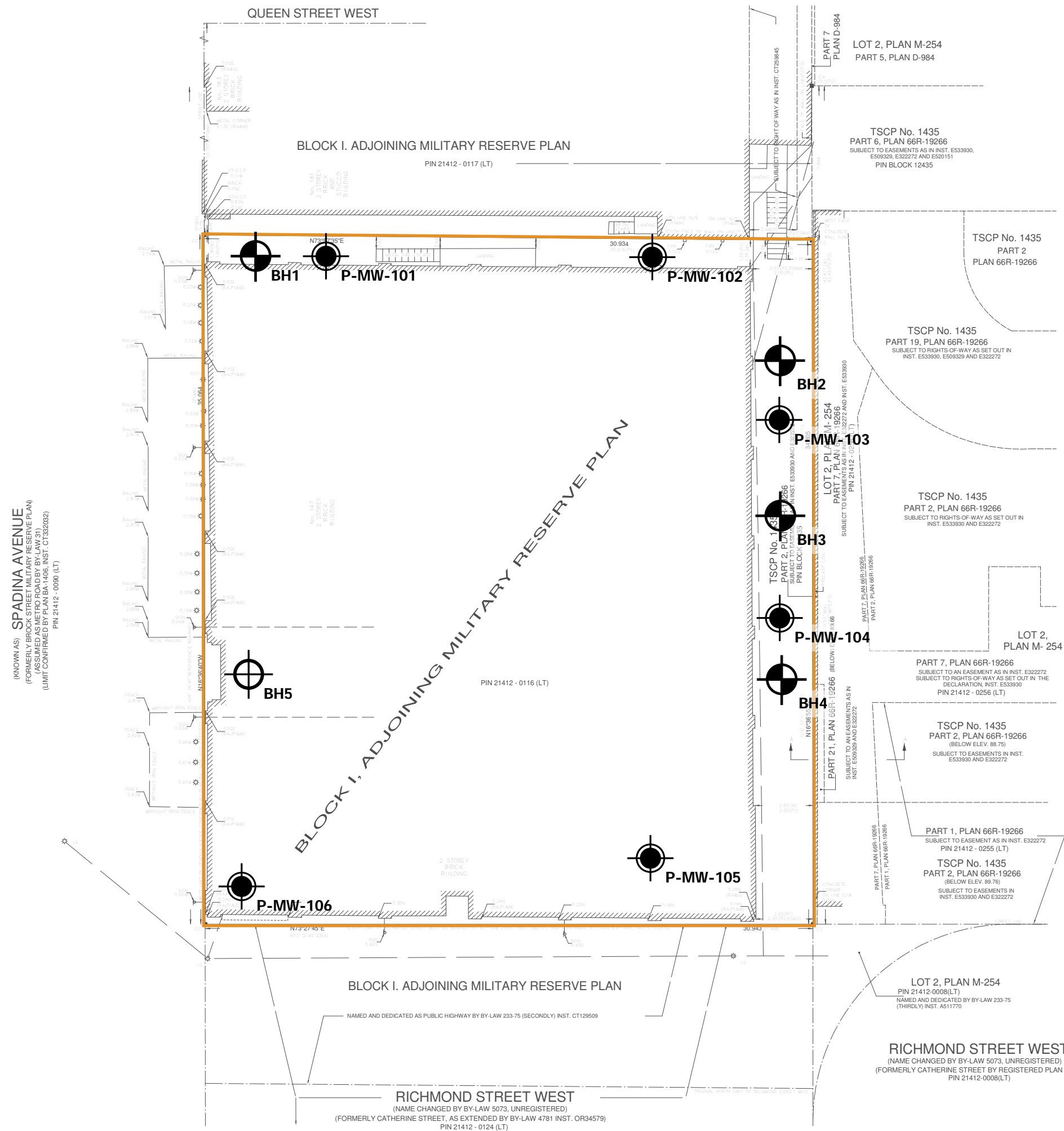



**GROUND
ENGINEERING**

12 Banigan Drive, Toronto, Ont., M4H 1E9
www.groundedeng.ca

LEGEND

— APPROXIMATE PROPERTY BOUNDARY

⊕ ⊖ GROUNDING BOREHOLE / MONITORING WELL LOCATION

⊕ ⊖ BOREHOLE LOCATION WITH MONITORING WELL BY OTHERS

Note

Reference

Architectural Plans, "147 Spadina Avenue, Toronto, Ontario"; File no 20-006, dated August 10, 2021, prepared by Audax Architecture Inc.

Project

**147 SPADINA AVENUE,
TORONTO, ONTARIO**

Figure Title

**BOREHOLE AND
MONITORING WELL
LOCATION PLAN (Proposed)**

North

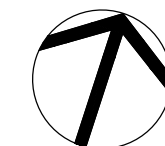

Date

AUGUST 2021

Scale

AS INDICATED

Job No

21-019

Figure No

FIGURE 3

SPADINA AVENUE

(FORMERLY BROOK STREET MILITARY RESERVE PLAN)
(ASSUMED AS SHOWN)
(LIMIT CONFIRMED BY PLAN BA-1408, INST. CT332082)
PIN 21412-0080(LT)

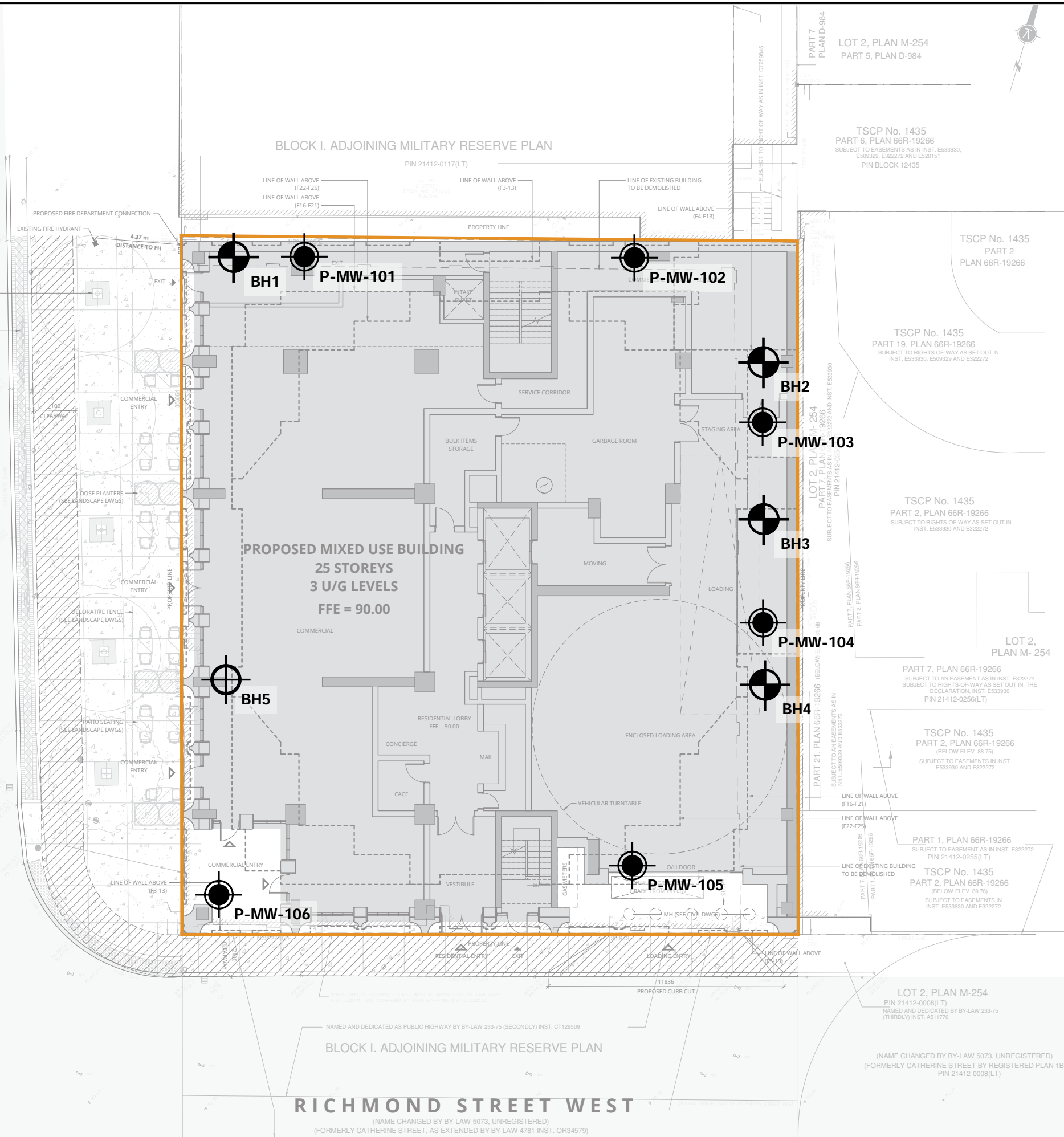

BLOCK I. ADJOINING MILITARY RESERVE PLAN

PIN 21412-0117(LT)

LINE OF WALL ABOVE (F22-F25)
LINE OF WALL ABOVE (F16-F21)

LINE OF WALL ABOVE (F3-13)

LINE OF WALL ABOVE (F4-F13)

LINE OF EXISTING BUILDING TO BE DEMOLISHED

PROPERTY LINE

**PROPOSED MIXED USE BUILDING
25 STOREYS
3 U/G LEVELS
FFE = 90.00**

COMMERCIAL

RESIDENTIAL LOBBY
FFE = 90.00

COMMERCIAL

BLOCK I. ADJOINING MILITARY RESERVE PLAN

RICHMOND STREET WEST

(NAME CHANGED BY BY-LAW 5073, UNREGISTERED)
(FORMERLY CATHERINE STREET, AS EXTENDED BY BY-LAW 4781 INST. OR34579)
PIN 21412-0124(LT)

PART 7, PLAN D-984
LOT 2, PLAN M-254
PART 5, PLAN D-984

TSCP No. 1435
PART 6, PLAN 66R-19266
SUBJECT TO EASEMENTS AS IN INST. E533930,
E509329, E322272 AND E520151
PIN BLOCK 12435

TSCP No. 1435
PART 2
PLAN 66R-19266

TSCP No. 1435
PART 19, PLAN 66R-19266
SUBJECT TO RIGHTS-OF-WAY AS SET OUT IN
INST. E533930, E509329 AND E322272

TSCP No. 1435
PART 2, PLAN 66R-19266
SUBJECT TO RIGHTS-OF-WAY AS SET OUT IN
INST. E533930 AND E322272

PART 7, PLAN 66R-19266
SUBJECT TO AN EASEMENT AS IN INST. E322272
SUBJECT TO RIGHTS-OF-WAY AS SET OUT IN THE
DECLARATION, INST. E533930
PIN 21412-0256(LT)

TSCP No. 1435
PART 2, PLAN 66R-19266
(BELOW ELEV. 88.75)
SUBJECT TO EASEMENTS IN INST.
E533930 AND E322272

PART 1, PLAN 66R-19266
SUBJECT TO EASEMENT AS IN INST. E322272
PIN 21412-0255(LT)
TSCP No. 1435
PART 2, PLAN 66R-19266
(BELOW ELEV. 89.76)
SUBJECT TO EASEMENTS IN
INST. E533930 AND E322272

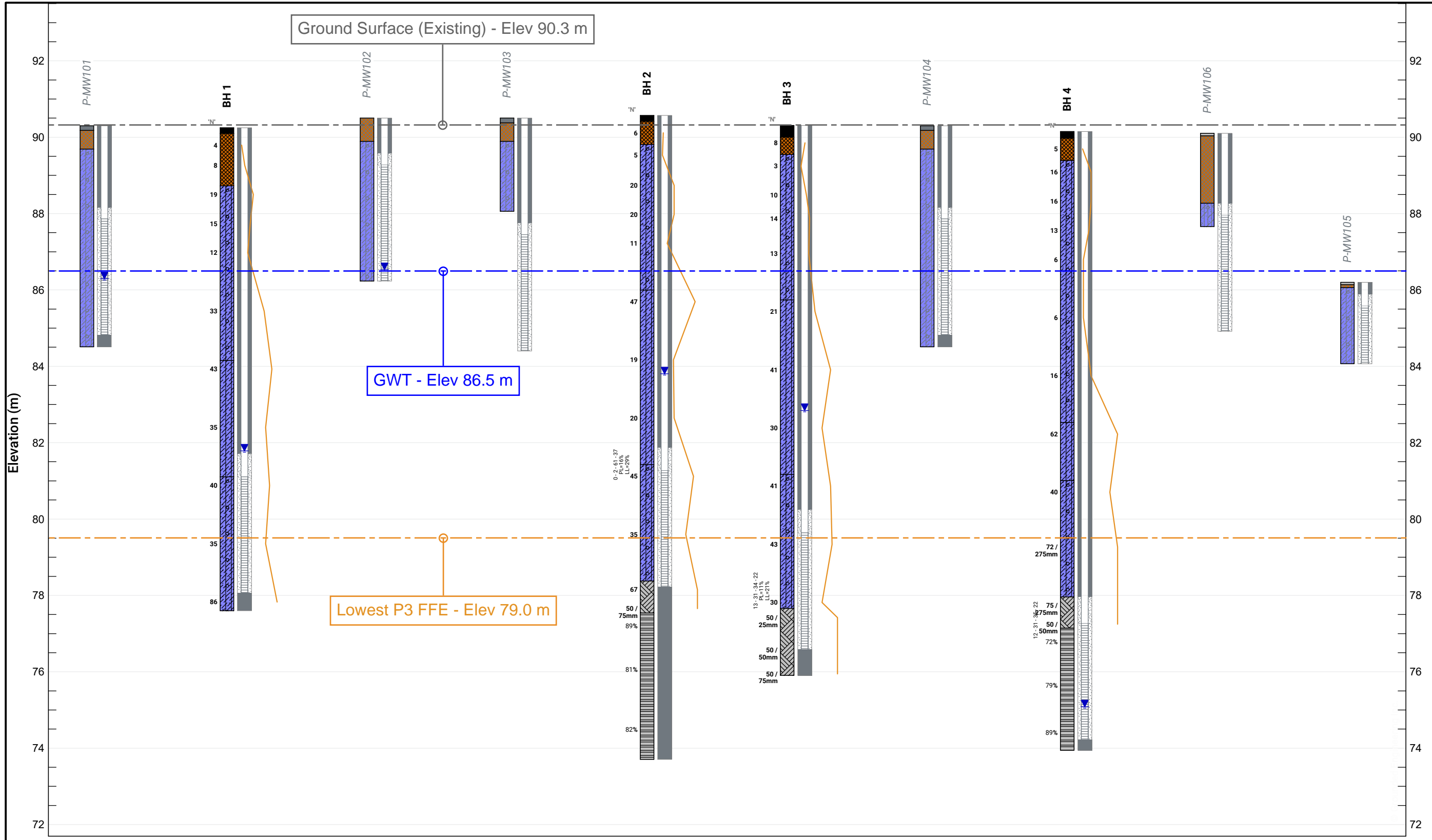

LOT 2, PLAN M-254
PIN 21412-0008(LT)
NAMED AND DEDICATED BY BY-LAW 233-75
(THIRDLY) INST. A511770

(NAME CHANGED BY BY-LAW 5073, UNREGISTERED)
(FORMERLY CATHERINE STREET BY REGISTERED PLAN 1B)
PIN 21412-0008(LT)



LEGEND

-  FILL
-  GRAVELS (gravel to gravelly sand)
-  SILT TO SAND (not till)
-  COHESIONLESS TILLS
-  COHESIVE SOILS (clayey silt to clay, incl. tills)
-  DISTURBED/REWORKED SOILS







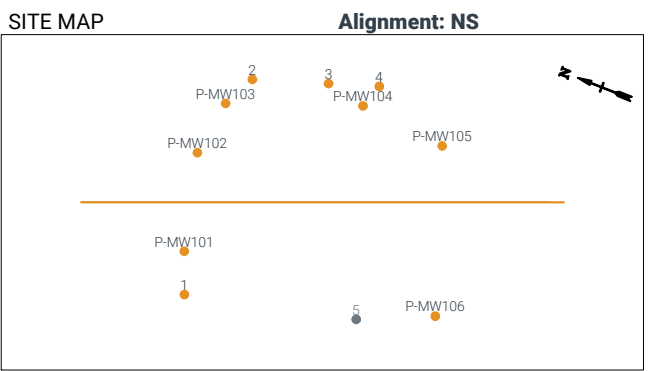

-  water level, unstabilized
-  water level, stabilized

Project
**147 SPADINA AVE
TORONTO, ON**

Figure Title
**SUBSURFACE
CROSS-SECTION**
NS



LITHOLOGY GRAPHIC LEGEND

-  Asphalt
-  Fill
-  Clayey Silt Till
-  Clayey Silt
-  Bedrock (inferred)
-  Bedrock (cored)
-  Concrete
-  Sandy Silt Till (clayey)

Date	JULY 2021
Scale	AS INDICATED
Job No	21-019
Figure No	FIGURE 4

APPENDIX A



SAMPLING/TESTING METHODS

SS: split spoon sample
 AS: auger sample
 GS: grab sample
 FV: shear vane
 DP: direct push
 PMT: pressuremeter test
 ST: shelby tube
 CORE: soil coring
 RUN: rock coring

SYMBOLS & ABBREVIATIONS

MC: moisture content
 LL: liquid limit
 PL: plastic limit
 PI: plasticity index
 γ : soil unit weight (bulk)
 G_s : specific gravity
 S_u : undrained shear strength
 unstabalized water level
 1st water level measurement
 2nd water level measurement most recent
 water level measurement

ENVIRONMENTAL SAMPLES

M&I: metals and inorganic parameters
 PAH: polycyclic aromatic hydrocarbon
 PCB: polychlorinated biphenyl
 VOC: volatile organic compound
 PHC: petroleum hydrocarbon
 BTEX: benzene, toluene, ethylbenzene and xylene
 PPM: parts per million

FIELD MOISTURE (based on tactile inspection)

DRY: no observable pore water
MOIST: inferred pore water, not observable (i.e. grey, cool, etc.)
WET: visible pore water

COHESIONLESS

Relative Density	N-Value
Very Loose	<4
Loose	4 - 10
Compact	10 - 30
Dense	30 - 50
Very Dense	>50

COHESIVE

Consistency	N-Value	Su (kPa)
Very Soft	<2	<12
Soft	2 - 4	12 - 25
Firm	4 - 8	25 - 50
Stiff	8 - 15	50 - 100
Very Stiff	15 - 30	100 - 200
Hard	>30	>200

COMPOSITION

Term	% by weight
trace silt	<10
some silt	10 - 20
silty	20 - 35
sand and silt	>35

ASTM STANDARDS

ASTM D1586 Standard Penetration Test (SPT)

Driving a 51 mm O.D. split-barrel sampler ("split spoon") into soil with a 63.5 kg weight free falling 760 mm. The blows required to drive the split spoon 300 mm ("bpf") after an initial penetration of 150 mm is referred to as the N-Value.

ASTM D3441 Cone Penetration Test (CPT)

Pushing an internal still rod with a outer hollow rod ("sleeve") tipped with a cone with an apex angle of 60° and a cross-sectional area of 1000 mm² into soil. The resistance is measured in the sleeve and at the tip to determine the skin friction and the tip resistance.

ASTM D2573 Field Vane Test (FVT)

Pushing a four blade vane into soil and rotating it from the surface to determine the torque required to shear a cylindrical surface with the vane. The torque is converted to the shear strength of the soil using a limit equilibrium analysis.

ASTM D1587 Shelby Tubes (ST)

Pushing a thin-walled metal tube into the in-situ soil at the bottom of a borehole, removing the tube and sealing the ends to prevent soil movement or changes in moisture content for the purposes of extracting a relatively undisturbed sample.

ASTM D4719 Pressuremeter Test (PMT)

Place an inflatable cylindrical probe into a pre-drilled hole and expanding it while measuring the change in volume and pressure in the probe. It is inflated under either equal pressure increments or equal volume increments. This provides the stress-strain response of the soil.

WELL LEGEND

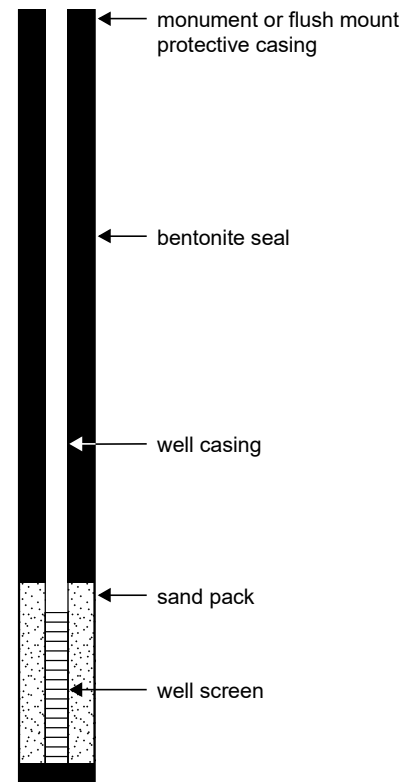

- TCR** **Total Core Recovery** the total length of recovery (soil or rock) per run, as a percentage of the drilled length
- SCR** **Solid Core Recovery** the total length of sound full-diameter rock core pieces per run, as a percentage of the drilled length
- RQD** **Rock Quality Designation** the sum of all pieces of sound rock core in a run which are 10 cm or greater in length, as a percentage of the drilled length

Natural Fracture Frequency (typically per 0.3 m) The number of natural discontinuities (joints, faults, etc.) which are present per 0.3m. Ignores mechanical or drill-induced breaks, and closed discontinuities (e.g. bedding planes).

LOGGING DISCONTINUITIES

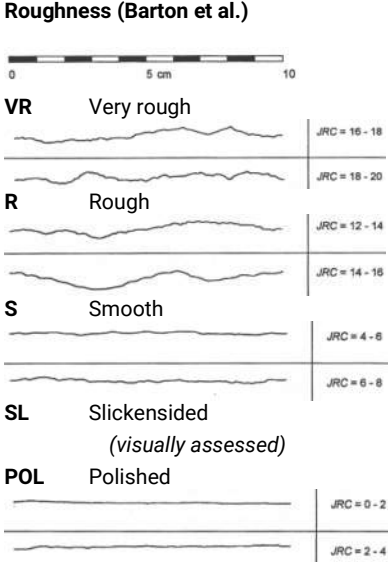
<p>Discontinuity Type</p> <p>BP bedding parting CL cleavage CS crushed seam FZ fracture zone MB mechanical break IS infilled seam JT Joint SS shear surface SZ shear zone VN vein VO void</p> <p>Coating</p> <p>CN Clean SN Stained OX Oxidized VN Veneer CT Coating (>1 mm)</p> <p>Dip Inclination</p> <p>H horizontal/flat 0 - 20° D dipping 20 - 50° SV sub-vertical 50 - 90° V vertical 90±°</p>	<p>Roughness (Barton et al.)</p>  <p>VR Very rough JRC = 16 - 18</p> <p>R Rough JRC = 12 - 14</p> <p>S Smooth JRC = 14 - 15</p> <p>SL Slickensided (visually assessed) JRC = 6 - 8</p> <p>POL Polished JRC = 0 - 2</p>	<p>Spacing in Discontinuity Sets (ISRM 1981)</p> <p>VC very close < 60 mm C close 60 – 200 mm M mod. close 0.2 to 0.6 m W wide 0.6 to 2 m VW very wide > 2 m</p> <p>Aperture Size</p> <p>T closed / tight < 0.5 mm GA gapped 0.5 to 10 mm OP open > 10 mm</p> <p>Planarity</p> <p>PR Planar UN Undulating ST Stepped IR Irregular DIS Discontinuous CU Curved</p>
---	--	---

GENERAL

Degree of Weathering (after MTO, RR229 Evaluation of Shales for Construction Projects)

Zone	Degree	Description
Z1	unweathered	shale, regular jointing
Z2	partially weathered	angular blocks of unweathered shale, no matrix, with chemically weathered but intact shale
Z3		soil-like matrix with frequent angular shale fragments < 25mm diameter
Z4a		soil-like matrix with occasional shale fragments < 3mm diameter
Z4b	fully weathered	soil-like matrix only

Strength classification (after Marinos and Hoek, 2001; ISRM 1981b)

Grade	UCS (MPa)	Field Estimate (Description)
R6	extremely strong > 250	can only be chipped by geological hammer
R5	very strong 100 - 250	requires many blows from geological hammer
R4	strong 50 - 100	requires more than one blow from geological hammer
R3	medium strong 25 - 50	can't be scraped, breaks under one blow from geological hammer
R2	weak 5 - 25	can be peeled / scraped with knife with difficulty
R1	very weak 1 - 5	easily scraped / peeled, crumbles under firm blow of geo. hammer
R0	extremely weak < 1	indented by thumbnail

Bedding Thickness (Q. J. Eng. Geology, Vol 3, 1970)

Very thickly bedded	> 2 m
Thickly bedded	0.6 – 2m
Medium bedded	200 – 600mm
Thinly bedded	60 – 200mm
Very thinly bedded	20 – 60mm
Laminated	6 – 20mm
Thinly Laminated	< 6mm

File No. : 21-019

Project : 147 Spadina Ave, Toronto, ON

Client : HM RB (147 Spadina) LP

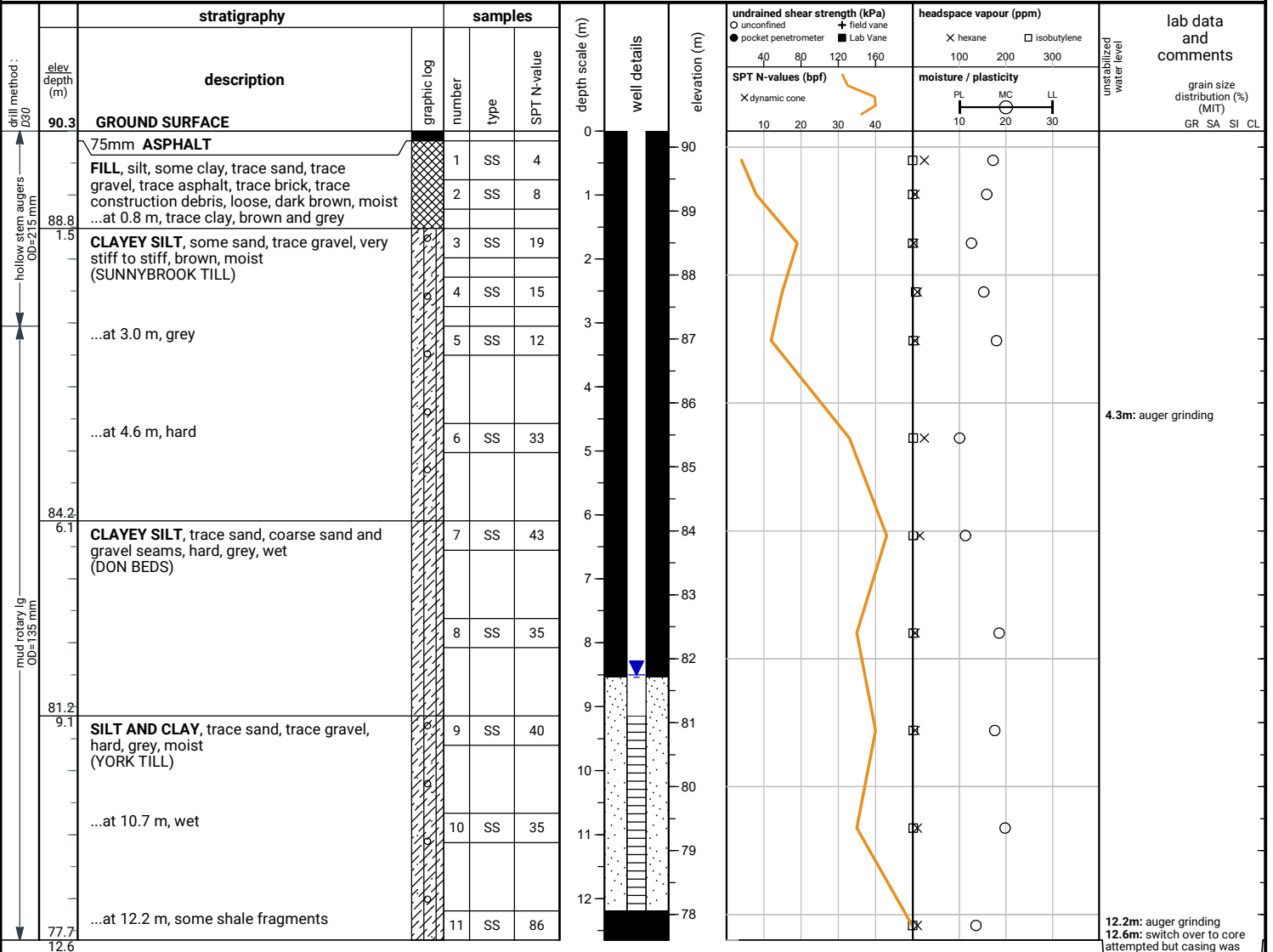

END OF BOREHOLE
Refusal (obstruction in the hole)

Borehole was filled with drill water upon completion of drilling.

50 mm dia. monitoring well installed.
No. 10 screen

GROUNDWATER LEVELS

Date	Water Depth (m)	Elevation (m)
Apr 16, 2021	10.6	79.7
May 31, 2021	9.2	81.1
Jun 11, 2021	9.0	81.3
Jun 25, 2021	8.6	81.7
Jul 8, 2021	8.7	81.6
Jul 21, 2021	8.5	81.8

File No. : 21-019

Project : 147 Spadina Ave, Toronto, ON

Client : HM RB (147 Spadina) LP

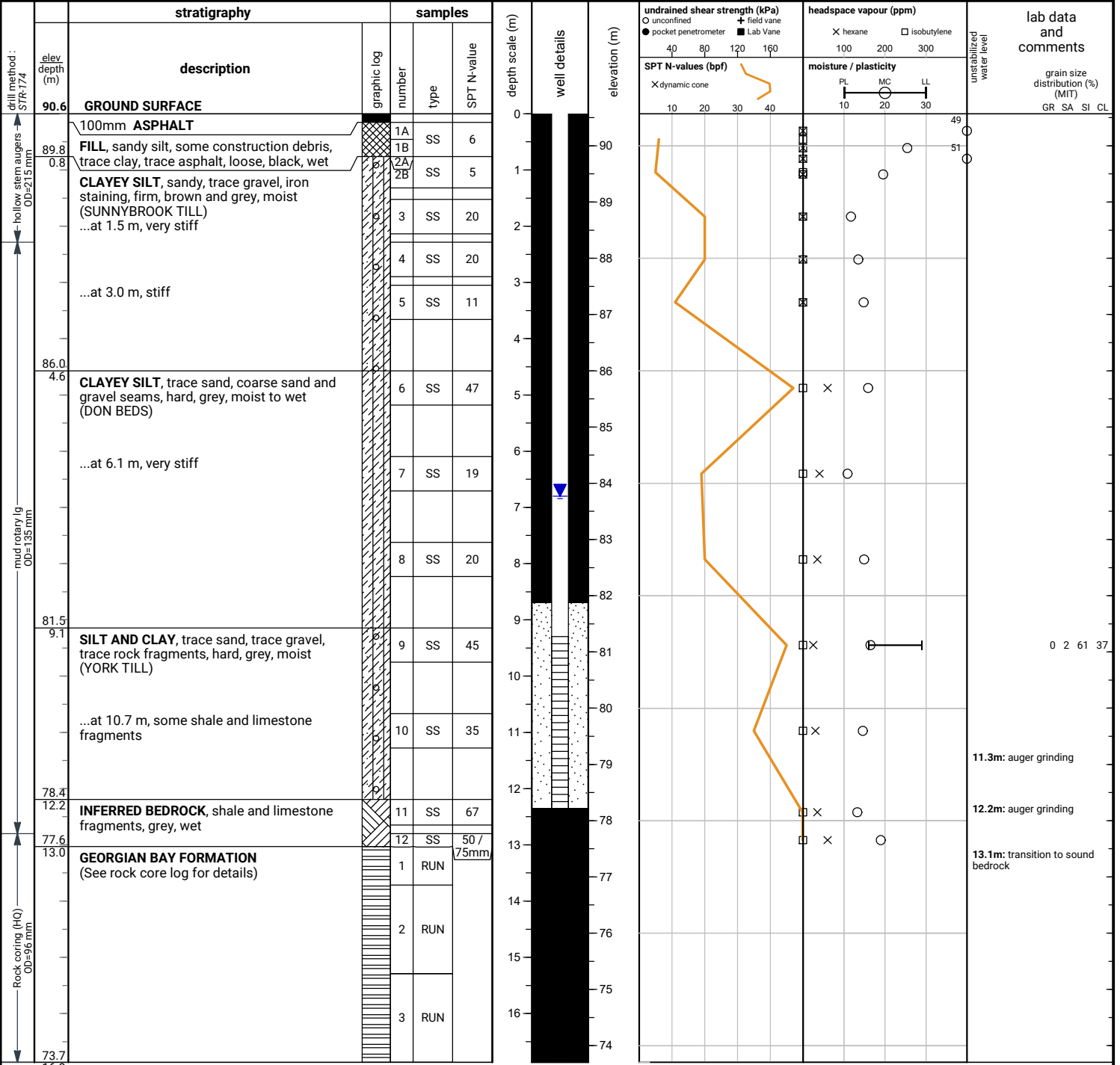

END OF BOREHOLE

Borehole was filled with drill water upon completion of drilling.

50 mm dia. monitoring well installed.
No. 10 screen

GROUNDWATER LEVELS

Date	Water Depth (m)	Elevation (m)
Feb 24, 2021	7.0	83.6
Mar 4, 2021	6.8	83.8
Mar 19, 2021	7.0	83.6
Apr 1, 2021	7.0	83.6
Apr 12, 2021	6.8	83.8
Apr 16, 2021	6.8	83.8
May 31, 2021	6.9	83.7
Jun 11, 2021	6.9	83.7
Jun 25, 2021	6.9	83.7
Jul 8, 2021	6.9	83.7
Jul 21, 2021	6.8	83.8

File No. : 21-019

Project : 147 Spadina Ave, Toronto, ON

Client : HM RB (147 Spadina) LP

depth (m)	graphic log	stratigraphy	Run elev depth (m)	recovery	elevation (m)	shale weathering zones	UCS (MPa)	natural fracture frequency	laboratory testing	notes and comments	elevation (m)		
												estimated strength	
												5	25
		Rock coring started at 13.0m below grade	77.6										
		GEORGIAN BAY FORMATION Shale, grey, thinly bedded, weak; joints are horizontal, closed to gapped, clean; interbedded with limestone, light grey, very thinly bedded, medium strong Overall shale: 81%, limestone: 19% ... at 13.1 m (Elev. 77.5 m), transition to sound rock	13.0										
			R1	TCR = 100% SCR = 96% RQD = 89%									
			76.9		77						77		
14			13.7										
		Run 1 : 15% limestone 85% shale	R2	TCR = 93% SCR = 89% RQD = 81%									
			75.3										
15			15.3		75						75		
		Run 2 : 10% limestone 90% shale											
			R3	TCR = 98% SCR = 90% RQD = 82%									
16			73.7		74						74		
		Run 3 : 29% limestone 71% shale											
			73.7										
			16.9m										

END OF COREHOLE

15.8 / 74.7m: RZ 50 mm

File No. : 21-019

Project : 147 Spadina Ave, Toronto, ON

Client : HM RB (147 Spadina) LP

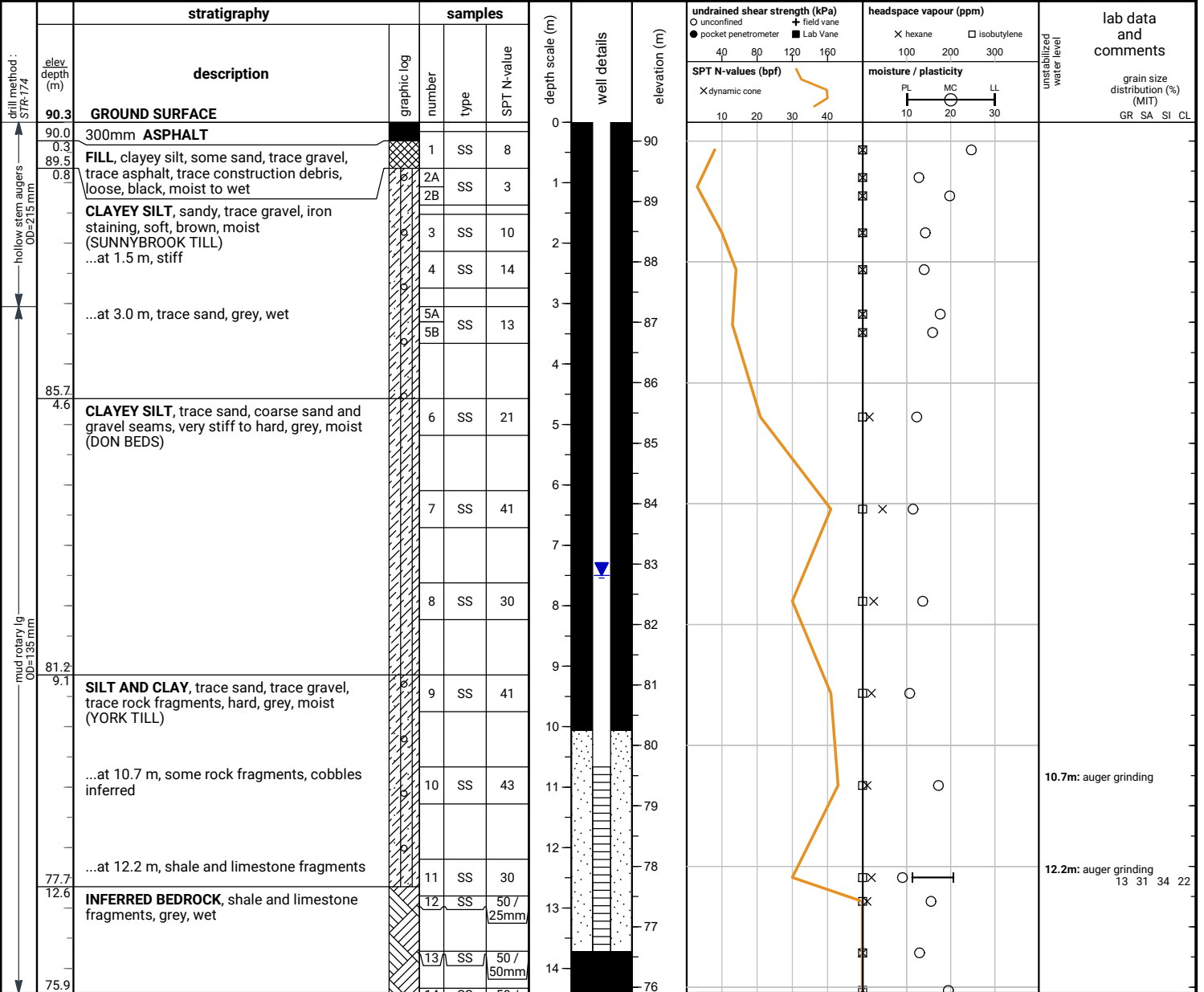

END OF BOREHOLE

Borehole was filled with drill water upon completion of drilling.

50 mm dia. monitoring well installed.
No. 10 screen

GROUNDWATER LEVELS

Date	Water Depth (m)	Elevation (m)
Feb 24, 2021	8.0	82.3
Mar 4, 2021	7.6	82.7
Mar 19, 2021	7.5	82.8
Apr 1, 2021	7.6	82.7
Apr 12, 2021	7.6	82.7
Apr 16, 2021	7.5	82.8
May 31, 2021	7.6	82.7
Jun 11, 2021	7.6	82.7
Jun 25, 2021	7.6	82.7
Jul 8, 2021	7.6	82.7
Jul 21, 2021	7.5	82.8

File No. : 21-019

Project : 147 Spadina Ave, Toronto, ON

Client : HM RB (147 Spadina) LP

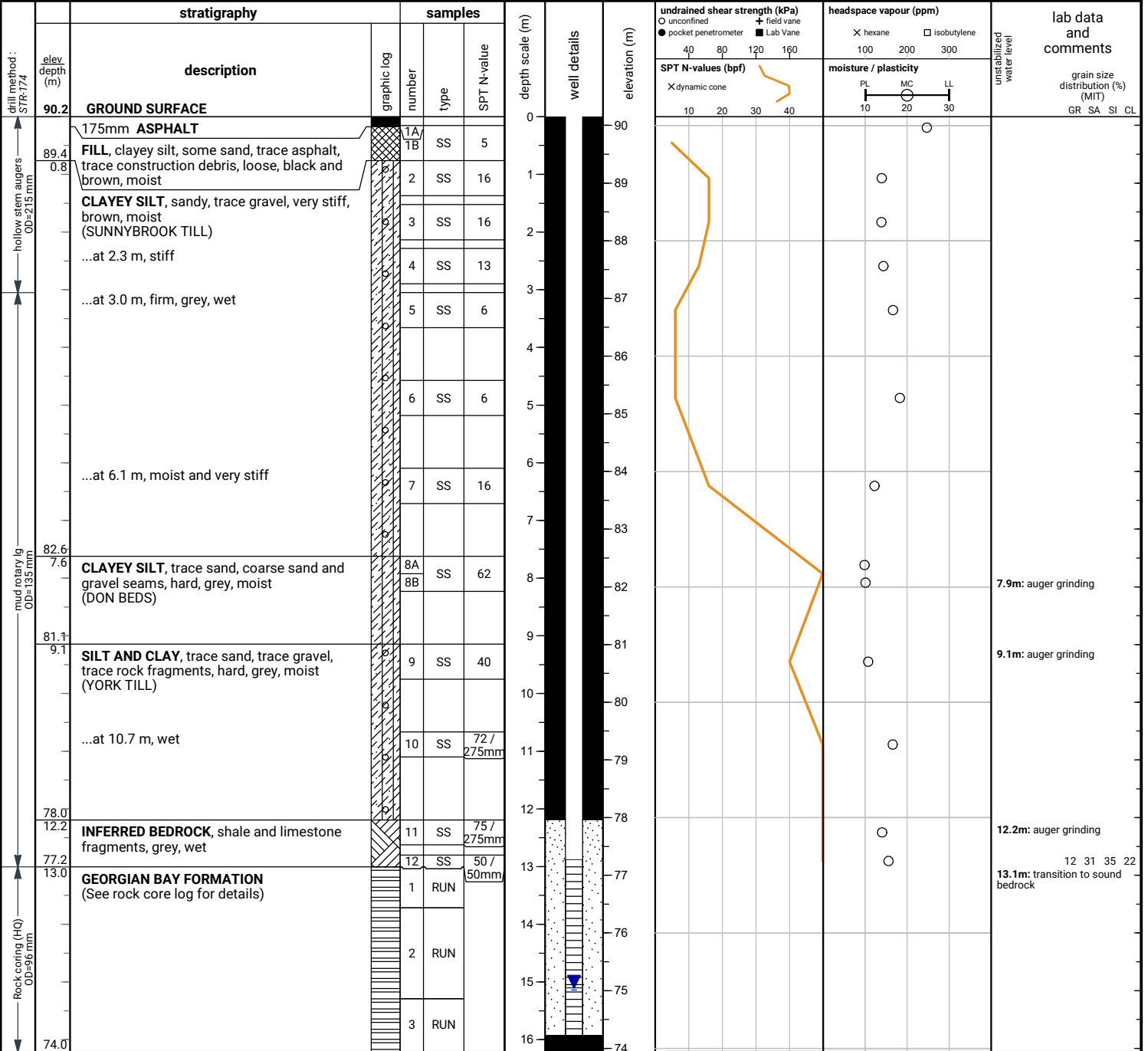

END OF BOREHOLE

Borehole was filled with drill water upon completion of drilling.
50 mm dia. monitoring well installed.
No. 10 screen

GROUNDWATER LEVELS

Date	Water Depth (m)	Elevation (m)
Feb 24, 2021	15.0	75.2
Mar 4, 2021	15.1	75.1
Mar 19, 2021	15.2	75.0
Apr 16, 2021	15.0	75.2
May 31, 2021	15.0	75.2
Jun 11, 2021	15.1	75.1
Jun 25, 2021	15.1	75.1
Jul 8, 2021	15.1	75.1
Jul 21, 2021	15.1	75.1

File No. : 21-019

Project : 147 Spadina Ave, Toronto, ON

Client : HM RB (147 Spadina) LP

depth (m)	graphic log	stratigraphy	run elev depth (m)	recovery	elevation (m)	shale weathering zones	UCS (MPa)		natural fracture frequency	laboratory testing	notes and comments	elevation (m)
							5	25				
		Rock coring started at 13.0m below grade	77.2									
		GEORGIAN BAY FORMATION Shale, grey, thickly bedded, weak; joints are horizontal, closed to gapped, clean; interbedded with limestone, light grey, very thinly bedded, medium strong Overall shale: 80%, limestone: 20% ... at 13.1 m (Elev. 77.1 m), transition to sound rock	13.0		77	Z1			1 + RZ			77
			R1	TCR = 129% SCR = 100% RQD = 72%		Z2			1			
			76.5			Z3			1			
14			13.7		76	Z4			1			76
		Run 1 : 3% limestone 97% shale	R2	TCR = 95% SCR = 95% RQD = 79%		R1			1			
						R2			3			
15		Run 2 : 16% limestone 84% shale			75	R3			1			75
			74.9			R4			5			
			15.3			R5			2			
16		Run 3 : 41% limestone 59% shale	R3	TCR = 97% SCR = 97% RQD = 89%		R6			1			74
			74.0		74							74

END OF COREHOLE

16.2m

File No. : 21-019

Project : 147 Spadina Ave, Toronto, ON

Client : HM RB (147 Spadina) LP

drill method : D30	stratigraphy		samples				depth scale (m)	well details	elevation (m)	undrained shear strength (kPa) ○ unconfined ● pocket penetrometer X dynamic cone	headspace vapour (ppm) X hexane □ isobutylene	lab data and comments grain size distribution (%) (MIT) GR SA SI CL
	elev. depth (m)	description	graphic log	number	type	SPT N-value						
90.0	GROUND SURFACE						0					0.1m: Void space encountered under floor slab. Borehole terminated due to unsupported floor slab, leading to unsafe drilling conditions.
89.6	100mm BRICK											
0.4	Void space											

END OF BOREHOLE

Dry and open upon completion of drilling.

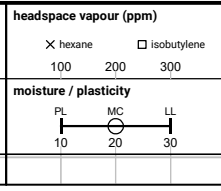
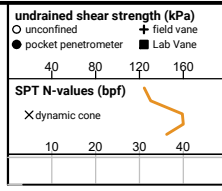

unstab. water level

APPENDIX B



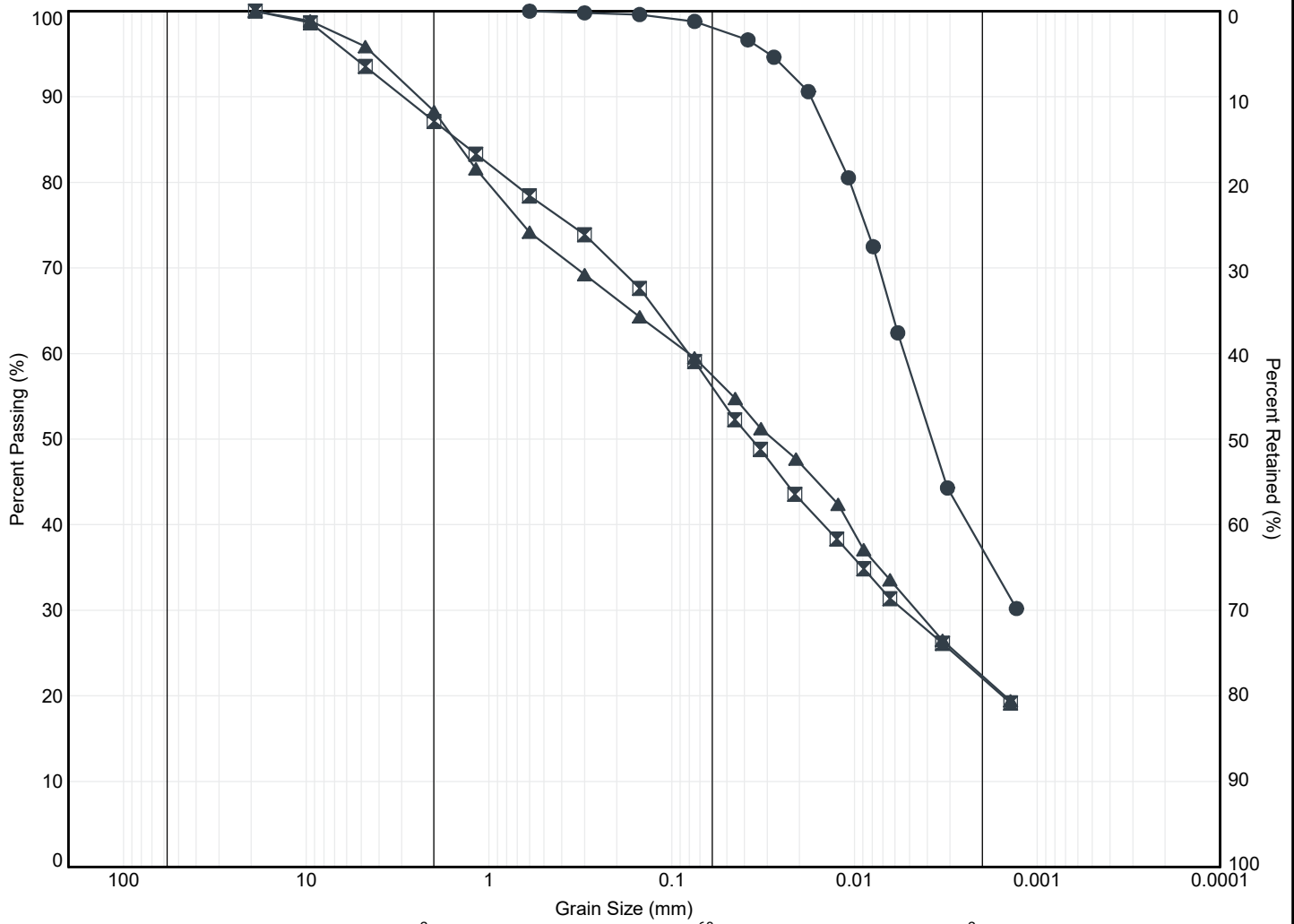

MIT SYSTEM	COBBLES	GRAVEL			SAND			SILT	CLAY
		COARSE	MEDIUM	FINE	COARSE	MEDIUM	FINE		

MIT SYSTEM

	Borehole	Sample	Depth (m)	Elev. (m)	Gravel (%)	Sand (%)	Silt (%)	Clay (%)
●	2	SS9	9.4	81.1	0	2	61	37
☒	3	SS11	12.5	77.8	13	31	34	22
▲	4	SS12	12.9	77.2	12	31	35	22



Title: **GRAIN SIZE DISTRIBUTION**

File No.: **21-019**

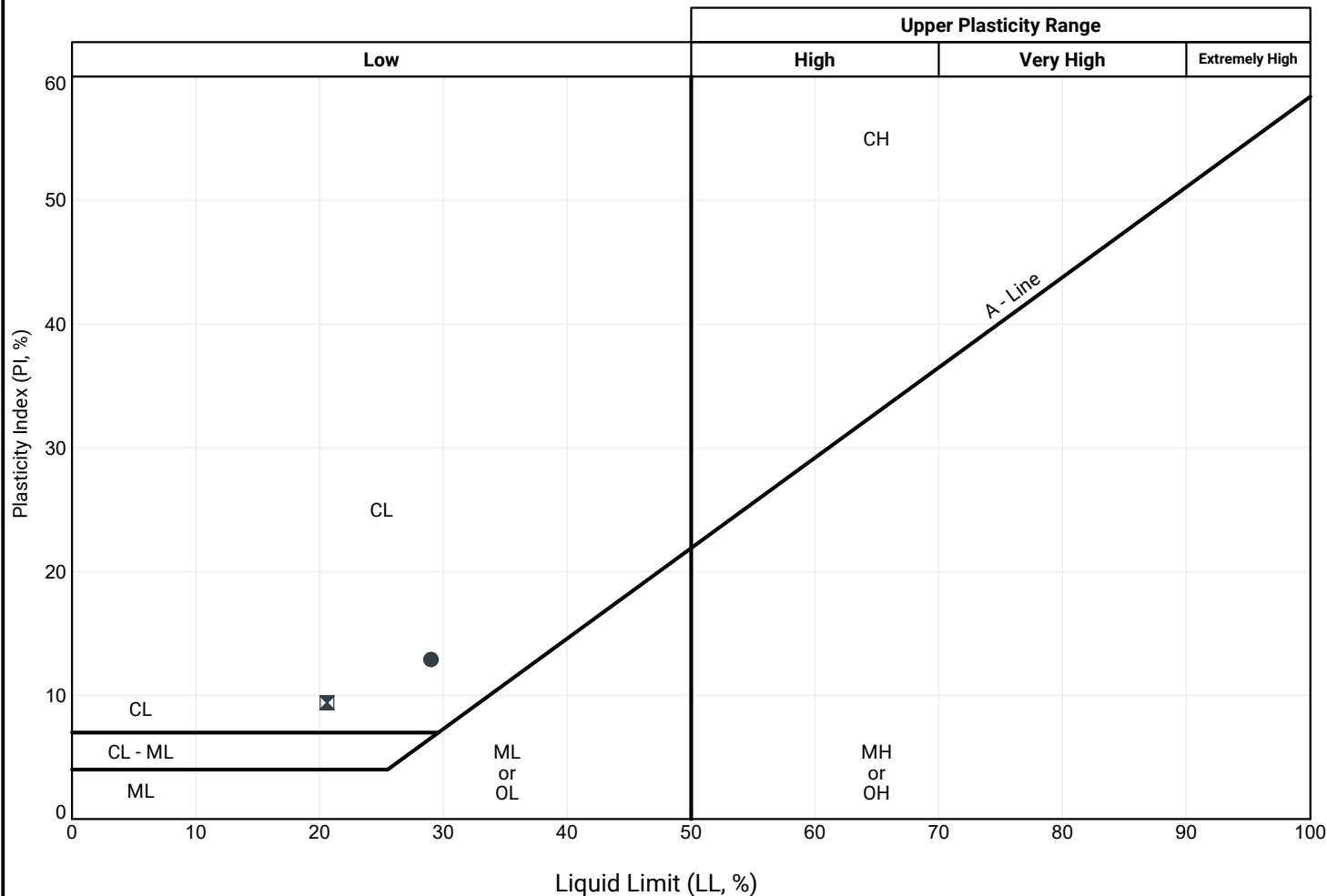

Borehole	Sample	Depth (m)	Elev. (m)	LL (%)	PL (%)	PI (%)
● 2	SS9	9.4	81.1	29	16	13
⊠ 3	SS11	12.5	77.8	21	11	10



APPENDIX C





Borehole 2 – Box 1



Depth: 13.0 to 15.3 m below grade (Elev. 77.6 to 75.3 m)

Borehole 2 – Box 2

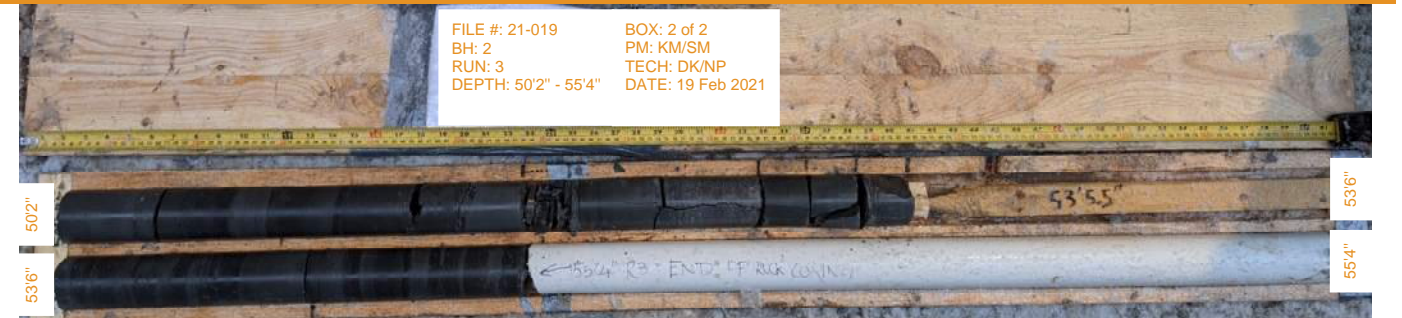

Depth: 15.3 to 16.9 m below grade (Elev. 75.3 to 73.7 m)

Borehole 4 – Box 1

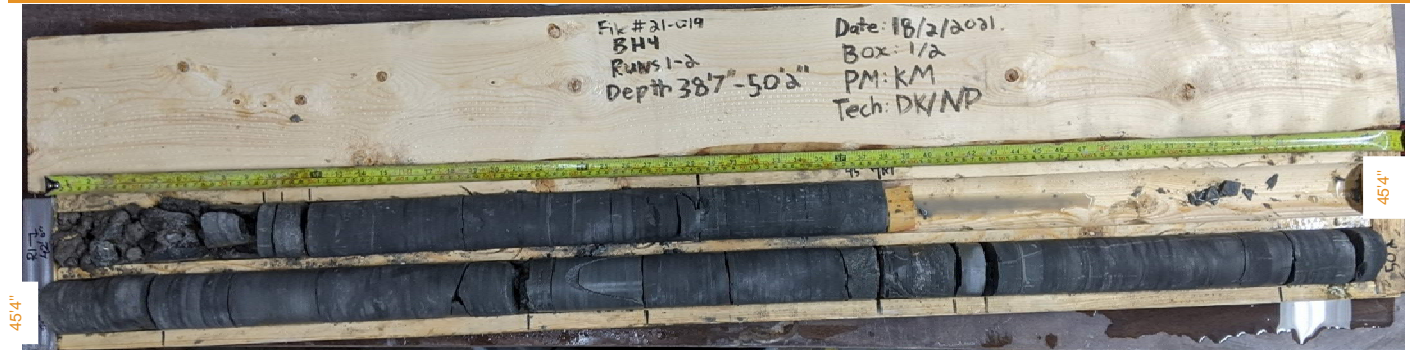

Depth: 13.0 to 15.3 m below grade (Elev. 77.2 to 74.9 m)

Borehole 4 – Box 2



Depth: 15.3 to 16.2 m below grade (Elev. 74.9 to 74.0 m)

APPENDIX D





Log of Borehole: MW101

Project #: 282626.003

Logged By: KW

Project: Phase Two Environmental Site Assessment

Client: HM RB (Spadina) Ltd.

Location: 147 Spadina Avenue, Toronto, Ontario

Drill Date: April 29, 2021

SUBSURFACE PROFILE				SAMPLE					
Depth	Symbol	Description	Measured Depth (m)	Monitoring Well Details	Recovery (%)	Sample ID	Soil Vapour Concentration* (ppm) CGI/PID	Laboratory Analysis	
0		Ground Surface	0.00						
0		Asphalt							
1		Sand and Silt Fill Dark brown, moist with brick and inferred coal fragments to 0.61 mbgs.	0.61			42	1	10/1	Metals and Inorganics, PAHs
2		Clayey Silt Brown with orange oxidation, some gravel, moist.					2	10/1	PHCs (F1-F4)/BTEX and VOCs
3									
4		Clayey Silt Brown with orange oxidation, some gravel, moist.							
5									
6		Grey oxidation, moist to wet.	2.13			63	3	10/1	
7									
8		Sand Seam Grey, some gravel, silt and clay.	2.44				4	0/0	
9									
10		Clayey Silt Grey, orange oxidation, moist to wet.			100	5	0/1		
11									
12		Wet at 3.35 mbgs.							
13									
14		Wet at 3.35 mbgs.			100	6	0/0		
15									
16		Moist to wet at 4.88 mbgs.							
17									
18		Wet at 5.49 mbgs.							
19									
20		End of Borehole	5.79						
21		Sampler refusal at 5.79 mbgs. Augured							
22									

Contractor: Strata Drilling Group Inc.

Drilling Method: Direct Push

Well Casing Size: 3.81 cm

Note:
* Soil vapour concentrations measured using a RKI Eagle 2 equipped with a combustible gas indicator (CGI) and a photoionization detector (PID).

Grade Elevation: 90.320 mamsl

Top of Casing Elevation: 90.219 mamsl

Sheet: 1 of 1



Log of Borehole: MW102

Project #: 282626.003

Logged By: KW

Project: Phase Two Environmental Site Assessment

Client: HM RB (Spadina) Ltd.

Location: 147 Spadina Avenue, Toronto, Ontario

Drill Date: April 29, 2021

SUBSURFACE PROFILE					SAMPLE			
Depth	Symbol	Description	Measured Depth (m)	Monitoring Well Details	Recovery (%)	Sample ID	Soil Vapour Concentration* (ppm) CGI/PID	Laboratory Analysis
0		Ground Surface	0.00					
1		Sand and Gravel Fill Brown, brick and glass debris throughout.	0.61		100	1	10/1	PHCs (F1-F4)/BTEX and VOCs
2		Dark grey from 0.46 to 0.61 mbgs.				2	10/0	Metals and Inorganics, PAHs
3		Clayey Silt Brown, some gravel, moist to wet.			100	3	10/0	
4		Grey-brown with orange oxidation at 2.13 mbgs.				4	0/1	
5		Some sand from 2.90 mbgs.			100	5	10/1	
6		Grey below 3.66 mbgs.				6	10/0	
7		End of Borehole	4.27		100	7	0/1	
8		Sampler refusal at 4.27 mbgs.		Water level was measured at 3.85				
9								
10								
11								
12								
13								
14								
15								
16								
17								
18								
19								
20								
21								
22								

Contractor: Strata Drilling Group Inc.

Drilling Method: Direct Push

Well Casing Size: 3.81 cm

Note:
* Soil vapour concentrations measured using a RKI Eagle 2 equipped with a combustible gas indicator (CGI) and a photoionization detector (PID).

Grade Elevation: 90.530 mamsl

Top of Casing Elevation: 90.417 mamsl

Sheet: 1 of 1



Log of Borehole: MW103

Project #: 282626.003

Logged By: KW

Project: Phase Two Environmental Site Assessment

Client: HM RB (Spadina) Ltd.

Location: 147 Spadina Avenue, Toronto, Ontario

Drill Date: April 26 and 27, 2021

SUBSURFACE PROFILE					SAMPLE			
Depth	Symbol	Description	Measured Depth (m)	Monitoring Well Details	Recovery (%)	Sample ID	Soil Vapour Concentration* (ppm) CGI/PID	Laboratory Analysis
0		Ground Surface	0.00					
0		Asphalt						
1		Sand and Silt Fill Dark brown, moist with brick and debris to 0.61 mbgs.	0.61		92	1	0/1	Metals and Inorganics, PAHs
2		Clayey Silt Brown with orange oxidation, some gravel, moist.				2	0/1	PHCs (F1-F4)/BTEX, VOCs
3								
4		Some sand at 1.22 mbgs.			100	3	0/0	
5								
6		End of Borehole	2.44		100	4	0/0	
7								
8								
9								
10								
11								
12								
13								
14								
15								
16								
17								
18								
19								
20								
21								
22								

Contractor: Strata Drilling Group Inc.

Drilling Method: Direct Push

Well Casing Size: 3.81 cm

Note:

* Soil vapour concentrations measured using a RKI Eagle 2 equipped with a combustible gas indicator (CGI) and a photoionization detector (PID).

Grade Elevation: 90.546 mamsl

Top of Casing Elevation: 90.380 mamsl

Sheet: 1 of 1



Log of Borehole: MW104

Project #: 282626.003

Logged By: KW

Project: Phase Two Environmental Site Assessment

Client: HM RB (Spadina) Ltd.

Location: 147 Spadina Avenue, Toronto, Ontario

Drill Date: April 26 and 27, 2021

SUBSURFACE PROFILE					SAMPLE				
Depth	Symbol	Description	Measured Depth (m)	Monitoring Well Details	Recovery (%)	Sample ID	Soil Vapour Concentration* (ppm) CGI/PID	Laboratory Analysis	
0		Ground Surface	0.00						
0		Asphalt							
1		Sand and Silt Fill Dark brown, moist with brick and inferred coal fragments to 0.61 mbgs.	0.61		92	1	0/1	Metals and Inorganics, PAHs	
2		Clayey Silt Brown with orange oxidation, some gravel, moist.				2	0/1	PHCs (F1-F4)/BTEX and VOCs	
3									
4		Grey oxidation, moist to wet.	2.13						
5		Sand Seam Grey, some gravel, silt and clay.	2.44			3	0/0		
6						4	10/0		
7		Clayey Silt Grey, orange oxidation, moist to wet.				5	10/0		
8						6	10/1	Grain Size and pH	
9		Wet at 3.35 mbgs.			7	0/0			
10					8	0/0			
11		Moist to wet at 4.88 mbgs.			9	0/1			
12		Wet at 5.49 mbgs.			10	0/0			
13									
14									
15									
16									
17									
18									
19			5.79	Water level was measured at 4.91 mbgs on June 4,					
20		End of Borehole							
21		Sampler refusal at 5.79 mbgs. Augured refusal at 5.49 mbgs.							
22									

Contractor: Strata Drilling Group Inc.

Drilling Method: Direct Push

Well Casing Size: 3.81 cm

Note:
* Soil vapour concentrations measured using a RKI Eagle 2 equipped with a combustible gas indicator (CGI) and a photoionization detector (PID).

Grade Elevation: 90.314 mamsl

Top of Casing Elevation: 90.172 mamsl

Sheet: 1 of 1



Log of Borehole: MW105

Project #: 282626.003

Logged By: KW

Project: Phase Two Environmental Site Assessment

Client: HM RB (Spadina) Ltd.

Location: 147 Spadina Avenue, Toronto, Ontario

Drill Date: April 27, 2021

SUBSURFACE PROFILE					SAMPLE			
Depth	Symbol	Description	Measured Depth (m)	Monitoring Well Details	Recovery (%)	Sample ID	Soil Vapour Concentration* (ppm) CGI/PID	Laboratory Analysis
0		Ground Surface	0.00					
0		Concrete			100	1	10/1	PHCs (F1-F4)/BTEX
1		Sand and Gravel Fill Black/dark brown.			100	2	0/1	Metals and Inorganics, PAHs
2		Clayey Silt Grey, some gravel, wet at 0.46 mbfs. Moist to wet at 0.61 mbfs.	2.13		100	3	0/0	
7		End of Borehole						
11		Sampler refusal at 2.13 mbfs.						
18				Water level was measured at 1.88 mbgs on June 4, 2021.				

Contractor: Strata Drilling Group Inc.

Drilling Method: Direct Push

Well Casing Size: 2.54 cm

Note:

* Soil vapour concentrations measured using a RKI Eagle 2 equipped with a combustible gas indicator (CGI) and a photoionization detector (PID).

Grade Elevation: 86.214 mamsl

Top of Casing Elevation: 86.180 mamsl

Sheet: 1 of 1



Log of Borehole: MW106

Project #: 282626.003

Logged By: KW

Project: Phase Two Environmental Site Assessment

Client: HM RB (Spadina) Ltd.

Location: 147 Spadina Avenue, Toronto, Ontario

Drill Date: June 4, 2021

SUBSURFACE PROFILE					SAMPLE			
Depth	Symbol	Description	Measured Depth (m)	Monitoring Well Details	Recovery (%)	Sample ID	Soil Vapour Concentration* (ppm) CGI/PID	Laboratory Analysis
0		Ground Surface	0.00					
1		Concrete	0.61		50	1	0/1	PHCs (F1-F4)/BTEX, VOCs, PAHs and Metals
2		Silty Sand Fill Brown, some gravel, some clay, moist.						
3		Silty Sand Fill Brown, light grey molting, some clay and trace gravel, moist.	1.83		55	2	0/0	pH and Grain Size
4		Silty Sand Fill Brown, light grey molting, some clay and trace gravel, moist.						
5		Sandy Silt Orange-brown, some clay, trace gravel, moist.	2.44					
6		End of Borehole						
7								
8								
9								
10								
11								
12								
13								
14								
15								
16								
17								
18								
19								
20								
21								
22								

Contractor: Strata Drilling Group Inc.

Drilling Method: Direct Push

Well Casing Size: 5.08 cm

Note:

* Soil vapour concentrations measured using a RKI Eagle 2 equipped with a combustible gas indicator (CGI) and a photoionization detector (PID).

Grade Elevation: 90.069 mamsl

Top of Casing Elevation: 89.987 mamsl

Sheet: 1 of 1

APPENDIX F





FINAL REPORT

CA15960-FEB21 R

21-019, 147 Spadina Ave, Toronto

Prepared for

Grounded Engineering Inc.

First Page

CLIENT DETAILS

Client Grounded Engineering Inc.
 Address 12 Banigan Drive
 Toronto, Ontario
 M4H1E9, Canada
 Contact Katrina Morgenroth
 Telephone
 Facsimile
 Email kmorgenroth@groundedeng.ca
 Project 21-019, 147 Spadina Ave, Toronto
 Order Number
 Samples Leachate (1)

LABORATORY DETAILS

Project Specialist Jill Campbell, B.Sc.,GISAS
 Laboratory SGS Canada Inc.
 Address 185 Concession St., Lakefield ON, K0L 2H0
 Telephone 2165
 Facsimile 705-652-6365
 Email jill.campbell@sgs.com
 SGS Reference CA15960-FEB21
 Received 02/24/2021
 Approved 03/03/2021
 Report Number CA15960-FEB21 R
 Date Reported 03/03/2021

COMMENTS

Temperature of Sample upon Receipt: 7 degrees C
 Cooling Agent Present:Yes
 Custody Seal Present:Yes
 Chain of Custody Number:018248
 TCLP metals reported at 10x DL
 RL of nits raised due to sample matrix

SIGNATORIES

Jill Campbell, B.Sc.,GISAS

TABLE OF CONTENTS

First Page.....	1-2
Index.....	3
Results.....	4-7
Exceedance Summary.....	8
QC Summary.....	9-14
Legend.....	15
Annexes.....	16



FINAL REPORT

CA15960-FEB21 R

Client: Grounded Engineering Inc.

Project: 21-019, 147 Spadina Ave, Toronto

Project Manager: Katrina Morgenroth

Samplers: Katrina Morgenroth

PACKAGE: REG558 - Acid rock Drainage

(LEACHATE)

Sample Number 6

Sample Name TCLP

Sample Matrix Leachate

Sample Date 24/02/2021

L1 = REG558 / LEACHATE / - - SCHEDULE 4 - -

Parameter	Units	RL	L1	Result
Acid rock Drainage				
Final pH	no unit	0.01		5.97

PACKAGE: REG558 - Metals and Inorganics

(LEACHATE)

Sample Number 6

Sample Name TCLP

Sample Matrix Leachate

Sample Date 24/02/2021

L1 = REG558 / LEACHATE / - - SCHEDULE 4 - -

Parameter	Units	RL	L1	Result
Metals and Inorganics				
Sample weight	g	0.001		100
Ext Fluid	#1 or #2	0.01		2
Ext Volume	mL	0.01		2000
Nitrite (as N)	as N mg/L	0.03		< 0.3 †
Nitrate (as N)	as N mg/L	0.06		< 0.6 †
Nitrate + Nitrite (as N)	as N mg/L	0.06	1000	< 0.6 †
Fluoride	mg/L	0.06	150	0.16
Cyanide (total)	mg/L	0.01	20	< 0.01
Arsenic	mg/L	0.002	2.5	0.002
Silver	mg/L	0.0005	5	< 0.0005
Barium	mg/L	0.0002	100	0.999
Boron	mg/L	0.02	500	0.10
Cadmium	mg/L	0.00003	0.5	0.0010



FINAL REPORT

CA15960-FEB21 R

Client: Grounded Engineering Inc.

Project: 21-019, 147 Spadina Ave, Toronto

Project Manager: Katrina Morgenroth

Samplers: Katrina Morgenroth

PACKAGE: **REG558 - Metals and Inorganics**
(LEACHATE)

Sample Number 6

Sample Name TCLP

Sample Matrix Leachate

Sample Date 24/02/2021

L1 = REG558 / LEACHATE / - - SCHEDULE 4 - -

Parameter	Units	RL	L1	Result
Metals and Inorganics (continued)				
Chromium	mg/L	0.0008	5	< 0.0008
Lead	mg/L	0.0001	5	0.0016
Selenium	mg/L	0.0004	1	0.0007
Uranium	mg/L	0.00002	10	0.0044

PACKAGE: **REG558 - Other (ORP)** (LEACHATE)

Sample Number 6

Sample Name TCLP

Sample Matrix Leachate

Sample Date 24/02/2021

L1 = REG558 / LEACHATE / - - SCHEDULE 4 - -

Parameter	Units	RL	L1	Result
Other (ORP)				
Mercury	mg/L	0.00001	0.1	< 0.00001

PACKAGE: **REG558 - PCBs** (LEACHATE)

Sample Number 6

Sample Name TCLP

Sample Matrix Leachate

Sample Date 24/02/2021

L1 = REG558 / LEACHATE / - - SCHEDULE 4 - -

Parameter	Units	RL	L1	Result
PCBs				
Polychlorinated Biphenyls (PCBs) - Total	mg/L	0.001	0.3	< 0.001



FINAL REPORT

CA15960-FEB21 R

Client: Grounded Engineering Inc.

Project: 21-019, 147 Spadina Ave, Toronto

Project Manager: Katrina Morgenroth

Samplers: Katrina Morgenroth

PACKAGE: **REG558 - SVOCs - PAHs**
(LEACHATE)

Sample Number 6

Sample Name TCLP

Sample Matrix Leachate

Sample Date 24/02/2021

L1 = REG558 / LEACHATE / - - SCHEDULE 4 - -

Parameter	Units	RL	L1	Result
SVOCs - PAHs				
Benzo(a)pyrene	mg/L	0.001	0.001	< 0.001

PACKAGE: **REG558 - VOCs** (LEACHATE)

Sample Number 6

Sample Name TCLP

Sample Matrix Leachate

Sample Date 24/02/2021

L1 = REG558 / LEACHATE / - - SCHEDULE 4 - -

Parameter	Units	RL	L1	Result
VOCs				
Methyl ethyl ketone	mg/L	0.8	200	< 0.8
Vinyl Chloride	mg/L	0.008	0.2	< 0.008
Dichloromethane	mg/L	0.02	5	< 0.02
Chloroform	mg/L	0.02	10	< 0.02
Trichloroethylene	mg/L	0.02	5	< 0.02
Tetrachloroethene	mg/L	0.02	3	< 0.02
Monochlorobenzene	mg/L	0.02	8	< 0.02
Carbon tetrachloride	mg/L	0.008	0.5	< 0.008
1,2-Dichlorobenzene	mg/L	0.02	20	< 0.02
1,4-Dichlorobenzene	mg/L	0.02	0.5	< 0.02
1,2-Dichloroethane	mg/L	0.02	0.5	< 0.02
1,1-Dichloroethylene	mg/L	0.02	1.4	< 0.02



FINAL REPORT

CA15960-FEB21 R

Client: Grounded Engineering Inc.

Project: 21-019, 147 Spadina Ave, Toronto

Project Manager: Katrina Morgenroth

Samplers: Katrina Morgenroth

PACKAGE: REG558 - VOCs - BTEX (LEACHATE)

Sample Number 6
Sample Name TCLP
Sample Matrix Leachate
Sample Date 24/02/2021

L1 = REG558 / LEACHATE / - - SCHEDULE 4 - -

Parameter	Units	RL	L1	Result
VOCs - BTEX				
Benzene	mg/L	0.02	0.5	< 0.02

EXCEEDANCE SUMMARY

No exceedances are present above the regulatory limit(s) indicated

QC SUMMARY

Anions by IC

Method: EPA300/MA300-Ions1.3 | Internal ref.: ME-CA-IENVIIC-LAK-AN-001

Parameter	QC batch Reference	Units	RL	Method Blank	Duplicate		LCS/Spike Blank			Matrix Spike / Ref.		
					RPD	AC (%)	Spike Recovery (%)	Recovery Limits (%)		Spike Recovery (%)	Recovery Limits (%)	
								Low	High		Low	High
Nitrate + Nitrite (as N)	DIO0009-MAR21	mg/L	0.06	<0.06	NA		NA			NA		
Nitrite (as N)	DIO0009-MAR21	mg/L	0.03	<0.03	ND	20	99	80	120	100	75	125
Nitrate (as N)	DIO0009-MAR21	mg/L	0.06	<0.06	ND	20	103	80	120	102	75	125

Cyanide by SFA

Method: SM 4500 | Internal ref.: ME-CA-IENVISFA-LAK-AN-005

Parameter	QC batch Reference	Units	RL	Method Blank	Duplicate		LCS/Spike Blank			Matrix Spike / Ref.		
					RPD	AC (%)	Spike Recovery (%)	Recovery Limits (%)		Spike Recovery (%)	Recovery Limits (%)	
								Low	High		Low	High
Cyanide (total)	SKA0009-MAR21	mg/L	0.01	<0.01	ND	10	93	90	110	92	75	125



FINAL REPORT

CA15960-FEB21 R

QC SUMMARY

Fluoride by Specific Ion Electrode

Method: SM 4500 | Internal ref.: ME-CA-IENVIEWL-LAK-AN-014

Parameter	QC batch Reference	Units	RL	Method Blank	Duplicate		LCS/Spike Blank			Matrix Spike / Ref.		
					RPD	AC (%)	Spike Recovery (%)	Recovery Limits (%)		Spike Recovery (%)	Recovery Limits (%)	
								Low	High		Low	High
Fluoride	EWL0003-MAR21	mg/L	0.06	<0.06	ND	10	103	90	110	NV	75	125

Inorganics-General

Method: EPA 7471A/SM 3112B | Internal ref.: ME-CA-IENVISPE-LAK-AN-004

Parameter	QC batch Reference	Units	RL	Method Blank	Duplicate		LCS/Spike Blank			Matrix Spike / Ref.		
					RPD	AC (%)	Spike Recovery (%)	Recovery Limits (%)		Spike Recovery (%)	Recovery Limits (%)	
								Low	High		Low	High
Mercury	EHG0001-MAR21	mg/L	0.00001	< 0.00001	ND	20	105	80	120	118	70	130

QC SUMMARY

Metals in aqueous samples - ICP-MS

Method: SM 3030/EPA 200.8 | Internal ref.: ME-CA-IENVISPE-LAK-AN-006

Parameter	QC batch Reference	Units	RL	Method Blank	Duplicate		LCS/Spike Blank			Matrix Spike / Ref.		
					RPD	AC (%)	Spike Recovery (%)	Recovery Limits (%)		Spike Recovery (%)	Recovery Limits (%)	
								Low	High		Low	High
Silver	EMS0011-MAR21	mg/L	0.0005	<0.00005	ND	20	109	90	110	109	70	130
Arsenic	EMS0011-MAR21	mg/L	0.002	<0.0002	ND	20	109	90	110	103	70	130
Barium	EMS0011-MAR21	mg/L	0.0002	<0.00002	0	20	108	90	110	105	70	130
Boron	EMS0011-MAR21	mg/L	0.02	<0.002	2	20	102	90	110	100	70	130
Cadmium	EMS0011-MAR21	mg/L	0.00003	3e-006	ND	20	109	90	110	103	70	130
Chromium	EMS0011-MAR21	mg/L	0.0008	<0.00008	ND	20	110	90	110	121	70	130
Lead	EMS0011-MAR21	mg/L	0.0001	<0.00001	9	20	104	90	110	102	70	130
Selenium	EMS0011-MAR21	mg/L	0.0004	<0.00004	0	20	106	90	110	126	70	130
Uranium	EMS0011-MAR21	mg/L	0.00002	<0.000002	ND	20	104	90	110	102	70	130

Polychlorinated Biphenyls

Method: MOE E3400/EPA 8082A | Internal ref.: ME-CA-IENVIGC-LAK-AN-001

Parameter	QC batch Reference	Units	RL	Method Blank	Duplicate		LCS/Spike Blank			Matrix Spike / Ref.		
					RPD	AC (%)	Spike Recovery (%)	Recovery Limits (%)		Spike Recovery (%)	Recovery Limits (%)	
								Low	High		Low	High
Polychlorinated Biphenyls (PCBs) - Total	GCM0009-MAR21	mg/L	0.001	< 0.001	NSS	30	91	60	140	NSS	60	140



FINAL REPORT

CA15960-FEB21 R

QC SUMMARY

Semi-Volatile Organics

Method: EPA 3510C/8270D | Internal ref.: ME-CA-IENVIGC-LAK-AN-005

Parameter	QC batch Reference	Units	RL	Method Blank	Duplicate		LCS/Spike Blank			Matrix Spike / Ref.		
					RPD	AC (%)	Spike Recovery (%)	Recovery Limits (%)		Spike Recovery (%)	Recovery Limits (%)	
								Low	High		Low	High
Benzo(a)pyrene	GCM0011-MAR21	mg/L	0.001	< 0.001	NSS	30	83	50	140	NSS	50	140

QC SUMMARY

Volatile Organics

Method: EPA 5030B/8260C | Internal ref.: ME-CA-ENVIGC-LAK-AN-004

Parameter	QC batch Reference	Units	RL	Method Blank	Duplicate		LCS/Spike Blank			Matrix Spike / Ref.		
					RPD	AC (%)	Spike Recovery (%)	Recovery Limits (%)		Spike Recovery (%)	Recovery Limits (%)	
								Low	High		Low	High
1,1-Dichloroethylene	GCM0017-MAR21	mg/L	0.02	<0.02	ND	30	106	60	130	106	50	140
1,2-Dichlorobenzene	GCM0017-MAR21	mg/L	0.02	<0.02	ND	30	102	60	130	100	50	140
1,2-Dichloroethane	GCM0017-MAR21	mg/L	0.02	<0.02	ND	30	100	60	130	98	50	140
1,4-Dichlorobenzene	GCM0017-MAR21	mg/L	0.02	<0.02	ND	30	102	60	130	101	50	140
Benzene	GCM0017-MAR21	mg/L	0.02	<0.02	ND	30	101	60	130	100	50	140
Carbon tetrachloride	GCM0017-MAR21	mg/L	0.008	<0.008	ND	30	102	60	130	102	50	140
Chloroform	GCM0017-MAR21	mg/L	0.02	<0.02	ND	30	100	60	130	100	50	140
Dichloromethane	GCM0017-MAR21	mg/L	0.02	<0.02	ND	30	101	60	130	100	50	140
Methyl ethyl ketone	GCM0017-MAR21	mg/L	0.8	<0.8	ND	30	92	50	140	97	50	140
Monochlorobenzene	GCM0017-MAR21	mg/L	0.02	<0.02	ND	30	102	60	130	100	50	140
Tetrachloroethene	GCM0017-MAR21	mg/L	0.02	<0.02	ND	30	102	60	130	102	50	140
Trichloroethylene	GCM0017-MAR21	mg/L	0.02	<0.02	ND	30	99	60	130	98	50	140
Vinyl Chloride	GCM0017-MAR21	mg/L	0.008	<0.008	ND	30	102	50	140	101	50	140

QC SUMMARY

Method Blank: a blank matrix that is carried through the entire analytical procedure. Used to assess laboratory contamination.

Duplicate: Paired analysis of a separate portion of the same sample that is carried through the entire analytical procedure. Used to evaluate measurement precision.

LCS/Spike Blank: Laboratory control sample or spike blank refer to a blank matrix to which a known amount of analyte has been added. Used to evaluate analyte recovery and laboratory accuracy without sample matrix effects.

Matrix Spike: A sample to which a known amount of the analyte of interest has been added. Used to evaluate laboratory accuracy with sample matrix effects.

Reference Material: a material or substance matrix matched to the samples that contains a known amount of the analyte of interest. A reference material may be used in place of a matrix spike.

RL: Reporting limit

RPD: Relative percent difference

AC: Acceptance criteria

Multielement Scan Qualifier: as the number of analytes in a scan increases, so does the chance of a limit exceedance by random chance as opposed to a real method problem. Thus, in multielement scans, for the LCS and matrix spike, up to 10% of the analytes may exceed the quoted limits by up to 10% absolute and the spike is considered acceptable.

Duplicate Qualifier: for duplicates as the measured result approaches the RL, the uncertainty associated with the value increases dramatically, thus duplicate acceptance limits apply only where the average of the two duplicates is greater than five times the RL.

Matrix Spike Qualifier: for matrix spikes, as the concentration of the native analyte increases, the uncertainty of the matrix spike recovery increases. Thus, the matrix spike acceptance limits apply only when the concentration of the matrix spike is greater than or equal to the concentration of the native analyte.

LEGEND

FOOTNOTES

NSS Insufficient sample for analysis.
RL Reporting Limit.
 ↑ Reporting limit raised.
 ↓ Reporting limit lowered.
NA The sample was not analysed for this analyte
ND Non Detect

Samples analysed as received. Solid samples expressed on a dry weight basis. "Temperature Upon Receipt" is representative of the whole shipment and may not reflect the temperature of individual samples.

Analysis conducted on samples submitted pursuant to or as part of Reg. 153/04, are in accordance to the Protocol for Analytical Methods Used in the Assessment of Properties under Part XV.1 of the Environmental Protection Act" published by the Ministry and dated March 9, 2004 as amended.

SGS provides criteria information (such as regulatory or guideline limits and summary of limit exceedances) as a service. Every attempt is made to ensure the criteria information in this report is accurate and current, however, it is not guaranteed. Comparison to the most current criteria is the responsibility of the client and SGS assumes no responsibility for the accuracy of the criteria levels indicated. This document is issued, on the Client's behalf, by the Company under its General Conditions of Service available on request and accessible at http://www.sgs.com/terms_and_conditions.htm. The Client's attention is drawn to the limitation of liability, indemnification and jurisdiction issues defined therein. Any other holder of this document is advised that information contained hereon reflects the Company's findings at the time of its intervention only and within the limits of Client's instructions, if any. The Company's sole responsibility is to its Client and this document does not exonerate parties to a transaction from exercising all their rights and obligations under the transaction documents.

This report must not be reproduced, except in full. This report supersedes all previous versions.

-- End of Analytical Report --

Received By: Oleg Morzn
 Received Date: 02/24/21 (mm/dd/yy)
 Received Time: 10:30 (hr : min)

Company: Grounded Eng
 Contact: Katrina Morgenroth
 Address: 12 Benigan Dr Toronto
 Phone: _____
 Fax: _____
 Email: K.morgenroth@groundedeng.ca

Received By (signature): _____
 Custody Seal Present: Yes No
 Custody Seal Intact: Yes No
 Cooling Agent Present: Yes No
 Temperature Upon Receipt (°C): 7.77

Quotation #: _____
 Project #: 21-019
 P.O. #: _____
 Site Location/ID: 147 Spadina Ave, TO

LAB LIMS #: CA-15960-Feb21
TURNAROUND TIME (TAT) REQUIRED
 Regular TAT (5-7days)
 TAT's are quoted in business days (exclude statutory holidays & weekends).
 Samples received after 6pm or on weekends: TAT begins next business day

RUSH TAT (Additional Charges May Apply): 1 Day 2 Days 3 Days 4 Days
PLEASE CONFIRM RUSH FEASIBILITY WITH SGS REPRESENTATIVE PRIOR TO SUBMISSION

Specify Due Date: _____
 *NOTE: DRINKING (POTABLE) WATER SAMPLES FOR HUMAN CONSUMPTION MUST BE SUBMITTED WITH SGS DRINKING WATER CHAIN OF CUSTODY

REPORT INFORMATION
 (same as Report Information)
 Company: _____
 Contact: _____
 Address: _____
 Phone: _____
 Email: _____

INVOICE INFORMATION
 Other Regulations:
 Reg 347/558 (3 Day min TAT)
 PWOO MMER Other: _____
 CCME MISA ODWS Not Reportable *See note

REGULATIONS
 O.Reg 153/04 O.Reg 406/19
 Table 1 Res/Park Soil Texture: _____
 Table 2 Ind/Com Coarse
 Table 3 Agri/Other Medium/Fine
 Table _____
 Soil Volume: <350m3 >350m3

RECORD OF SITE CONDITION (RSC) YES NO

SAMPLE IDENTIFICATION	DATE SAMPLED	TIME SAMPLED	# OF BOTTLES	MATRIX
1 TCLP	2/24/2021	9AM	1	Soil
2				
3				
4				
5				
6				
7				
8				
9				
10				
11				
12				

ANALYSIS REQUESTED

M & I	SVOC	PCB	PHC	VOC	Pest	Other (please specify)	TCLP
Field Filtered (Y/N) Metals & Inorganics (Cd, Ni-water) ICP Metals only (As, Ba, Be, B, Cd, Cr, Co, Cu, Pb, Mo, Ni, Se, V, Zn) PAHs only SVOCs (all incl PAHs, ABNs, CPs) PCBs (Total <input type="checkbox"/> Aroclor <input type="checkbox"/> F1-F4 + BTEX F1-F4 only VOCs (all incl BTEX BTEX only Pesticides (Organochlorine or specify other							
Water Characterization Pkg Sewer Use: Screening Levels Table: Appendix 2: 406/19 Leachate							
General <input type="checkbox"/> Extended <input type="checkbox"/>							
Specify TCLP tests M&I VOC PCB B(e)P ABN Ignit.							X

COMMENTS:

Observations/Comments/Special Instructions

Sampled By (NAME): Katrina Morgenroth Signature: Katrina Morgenroth Date: 02/24/21 (mm/dd/yy)
 Relinquished by (NAME): Katrina Morgenroth Signature: Katrina Morgenroth Date: 02/24/21 (mm/dd/yy)
 Revision # 1.4
 Date of Issue 22 May, 2020
 Note: Submission of samples to SGS is acknowledgement that you have been provided direction on sample collection/handling and transportation of samples. (2) Submission of samples to SGS is considered authorization for completion of work. Signatures may appear on this form or be retained on file in the contract, or in an alternative format (e.g. shipping documents). (3) Results may be sent by email to an unlimited number of addresses for no additional cost. Fax is available upon request. This document is issued by the Company under its General Conditions of Service accessible at http://www.sgs.com/terms_and_conditions.htm. (Printed copies are available upon request.) Attention is drawn to the limitation of liability, indemnification and jurisdiction issues defined therein.



FINAL REPORT

CA15961-FEB21 R1

21-019, 147 Spadina Ave, Toronto

Prepared for

Grounded Engineering Inc.

First Page

CLIENT DETAILS

Client Grounded Engineering Inc.
 Address 12 Banigan Drive
 Toronto, Ontario
 M4H1E9, Canada
 Contact Katrina Morgenroth
 Telephone
 Facsimile
 Email kmorgenroth@groundedeng.ca
 Project 21-019, 147 Spadina Ave, Toronto
 Order Number
 Samples Soil (3)

LABORATORY DETAILS

Project Specialist Brad Moore Hon. B.Sc
 Laboratory SGS Canada Inc.
 Address 185 Concession St., Lakefield ON, K0L 2H0
 Telephone 705-652-2143
 Facsimile 705-652-6365
 Email brad.moore@sgs.com
 SGS Reference CA15961-FEB21
 Received 02/24/2021
 Approved 03/01/2021
 Report Number CA15961-FEB21 R1
 Date Reported 03/01/2021

COMMENTS

Temperature of Sample upon Receipt: 7 degrees C
 Cooling Agent Present: Yes
 Custody Seal Present: Yes

Chain of Custody Number: 018247

Corrosivity Index is based on the American Water Works Corrosivity Scale according to AWWA C-105. An index greater than 10 indicates the soil matrix may be corrosive to cast iron alloys.

SIGNATORIES

Brad Moore Hon. B.Sc

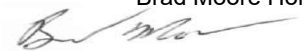

TABLE OF CONTENTS

First Page.....	1
Index.....	2
Results.....	3-4
QC Summary.....	5-6
Legend.....	7
Annexes.....	8



FINAL REPORT

CA15961-FEB21 R1

Client: Grounded Engineering Inc.

Project: 21-019, 147 Spadina Ave, Toronto

Project Manager: Katrina Morgenroth

Samplers: Katrina Morgenroth

PACKAGE: - Corrosivity Index (SOIL)

Sample Number	5	6	7
Sample Name	BH2 - SS2B	BH3 - SS3	BH4 - SS2
Sample Matrix	Soil	Soil	Soil
Sample Date	24/02/2021	24/02/2021	24/02/2021

Parameter	Units	RL	Result	Result	Result
-----------	-------	----	--------	--------	--------

Corrosivity Index

Corrosivity Index	none	1	2	4	11
Soil Redox Potential	mV	-	180	204	259
Sulphide (Na ₂ CO ₃)	%	0.04	< 0.04	< 0.04	< 0.04
pH	pH Units	0.05	8.26	8.52	8.36
Resistivity (calculated)	ohms.cm	-9999	2930	3440	598

PACKAGE: - General Chemistry (SOIL)

Sample Number	5	6	7
Sample Name	BH2 - SS2B	BH3 - SS3	BH4 - SS2
Sample Matrix	Soil	Soil	Soil
Sample Date	24/02/2021	24/02/2021	24/02/2021

Parameter	Units	RL	Result	Result	Result
-----------	-------	----	--------	--------	--------

General Chemistry

Conductivity	uS/cm	2	341	291	1670
--------------	-------	---	-----	-----	------

PACKAGE: - Metals and Inorganics (SOIL)

Sample Number	5	6	7
Sample Name	BH2 - SS2B	BH3 - SS3	BH4 - SS2
Sample Matrix	Soil	Soil	Soil
Sample Date	24/02/2021	24/02/2021	24/02/2021

Parameter	Units	RL	Result	Result	Result
-----------	-------	----	--------	--------	--------

Metals and Inorganics

Moisture Content	%	0.1	18.4	12.7	13.8
Sulphate	µg/g	0.4	35	34	47



FINAL REPORT

CA15961-FEB21 R1

Client: Grounded Engineering Inc.

Project: 21-019, 147 Spadina Ave, Toronto

Project Manager: Katrina Morgenroth

Samplers: Katrina Morgenroth

PACKAGE: - Other (ORP) (SOIL)

Sample Number	5	6	7
Sample Name	BH2 - SS2B	BH3 - SS3	BH4 - SS2
Sample Matrix	Soil	Soil	Soil
Sample Date	24/02/2021	24/02/2021	24/02/2021

Parameter	Units	RL	Result	Result	Result
Other (ORP)					
Chloride	µg/g	0.4	82	50	870

QC SUMMARY

Anions by IC

Method: EPA300/MA300-Ions1.3 | Internal ref.: ME-CA-IENVIIC-LAK-AN-001

Parameter	QC batch Reference	Units	RL	Method Blank	Duplicate		LCS/Spike Blank			Matrix Spike / Ref.		
					RPD	AC (%)	Spike Recovery (%)	Recovery Limits (%)		Spike Recovery (%)	Recovery Limits (%)	
								Low	High		Low	High
Chloride	DIO0302-FEB21	µg/g	0.4	<0.4	5	20	97	80	120	118	75	125
Sulphate	DIO0302-FEB21	µg/g	0.4	<0.4	7	20	95	80	120	92	75	125

Carbon/Sulphur

Method: ASTM E1915-07A | Internal ref.: ME-CA-IENVIARD-LAK-AN-020

Parameter	QC batch Reference	Units	RL	Method Blank	Duplicate		LCS/Spike Blank			Matrix Spike / Ref.		
					RPD	AC (%)	Spike Recovery (%)	Recovery Limits (%)		Spike Recovery (%)	Recovery Limits (%)	
								Low	High		Low	High
Sulphide (Na ₂ CO ₃)	ECS0035-FEB21	%	0.04	< 0.04	ND	20	110	80	120			

Conductivity

Method: SM 2510 | Internal ref.: ME-CA-IENVIEWL-LAK-AN-006

Parameter	QC batch Reference	Units	RL	Method Blank	Duplicate		LCS/Spike Blank			Matrix Spike / Ref.		
					RPD	AC (%)	Spike Recovery (%)	Recovery Limits (%)		Spike Recovery (%)	Recovery Limits (%)	
								Low	High		Low	High
Conductivity	EWL0349-FEB21	uS/cm	2	< 2	0	20	97	90	110	NA		

QC SUMMARY

pH

Method: SM 4500 | Internal ref.: ME-CA-ENVIEWL-LAK-AN-001

Parameter	QC batch Reference	Units	RL	Method Blank	Duplicate		LCS/Spike Blank			Matrix Spike / Ref.		
					RPD	AC (%)	Spike Recovery (%)	Recovery Limits (%)		Spike Recovery (%)	Recovery Limits (%)	
								Low	High		Low	High
pH	EWL0349-FEB21	pH Units	0.05	NA	0		100			NA		

Method Blank: a blank matrix that is carried through the entire analytical procedure. Used to assess laboratory contamination.

Duplicate: Paired analysis of a separate portion of the same sample that is carried through the entire analytical procedure. Used to evaluate measurement precision.

LCS/Spike Blank: Laboratory control sample or spike blank refer to a blank matrix to which a known amount of analyte has been added. Used to evaluate analyte recovery and laboratory accuracy without sample matrix effects.

Matrix Spike: A sample to which a known amount of the analyte of interest has been added. Used to evaluate laboratory accuracy with sample matrix effects.

Reference Material: a material or substance matrix matched to the samples that contains a known amount of the analyte of interest. A reference material may be used in place of a matrix spike.

RL: Reporting limit

RPD: Relative percent difference

AC: Acceptance criteria

Multielement Scan Qualifier: as the number of analytes in a scan increases, so does the chance of a limit exceedance by random chance as opposed to a real method problem. Thus, in multielement scans, for the LCS and matrix spike, up to 10% of the analytes may exceed the quoted limits by up to 10% absolute and the spike is considered acceptable.

Duplicate Qualifier: for duplicates as the measured result approaches the RL, the uncertainty associated with the value increases dramatically, thus duplicate acceptance limits apply only where the average of the two duplicates is greater than five times the RL.

Matrix Spike Qualifier: for matrix spikes, as the concentration of the native analyte increases, the uncertainty of the matrix spike recovery increases. Thus, the matrix spike acceptance limits apply only when the concentration of the matrix spike is greater than or equal to the concentration of the native analyte.

LEGEND

FOOTNOTES

NSS Insufficient sample for analysis.
RL Reporting Limit.
 ↑ Reporting limit raised.
 ↓ Reporting limit lowered.
NA The sample was not analysed for this analyte
ND Non Detect

Samples analysed as received. Solid samples expressed on a dry weight basis. "Temperature Upon Receipt" is representative of the whole shipment and may not reflect the temperature of individual samples.

Analysis conducted on samples submitted pursuant to or as part of Reg. 153/04, are in accordance to the Protocol for Analytical Methods Used in the Assessment of Properties under Part XV.1 of the Environmental Protection Act" published by the Ministry and dated March 9, 2004 as amended.

SGS provides criteria information (such as regulatory or guideline limits and summary of limit exceedances) as a service. Every attempt is made to ensure the criteria information in this report is accurate and current, however, it is not guaranteed. Comparison to the most current criteria is the responsibility of the client and SGS assumes no responsibility for the accuracy of the criteria levels indicated. This document is issued, on the Client's behalf, by the Company under its General Conditions of Service available on request and accessible at http://www.sgs.com/terms_and_conditions.htm. The Client's attention is drawn to the limitation of liability, indemnification and jurisdiction issues defined therein. Any other holder of this document is advised that information contained hereon reflects the Company's findings at the time of its intervention only and within the limits of Client's instructions, if any. The Company's sole responsibility is to its Client and this document does not exonerate parties to a transaction from exercising all their rights and obligations under the transaction documents.

This report must not be reproduced, except in full. This report supersedes all previous versions.

-- End of Analytical Report --

APPENDIX E



OBJECTS ARE COLOR-CODED
BETWEEN TWO VIEWS FOR CLARITY

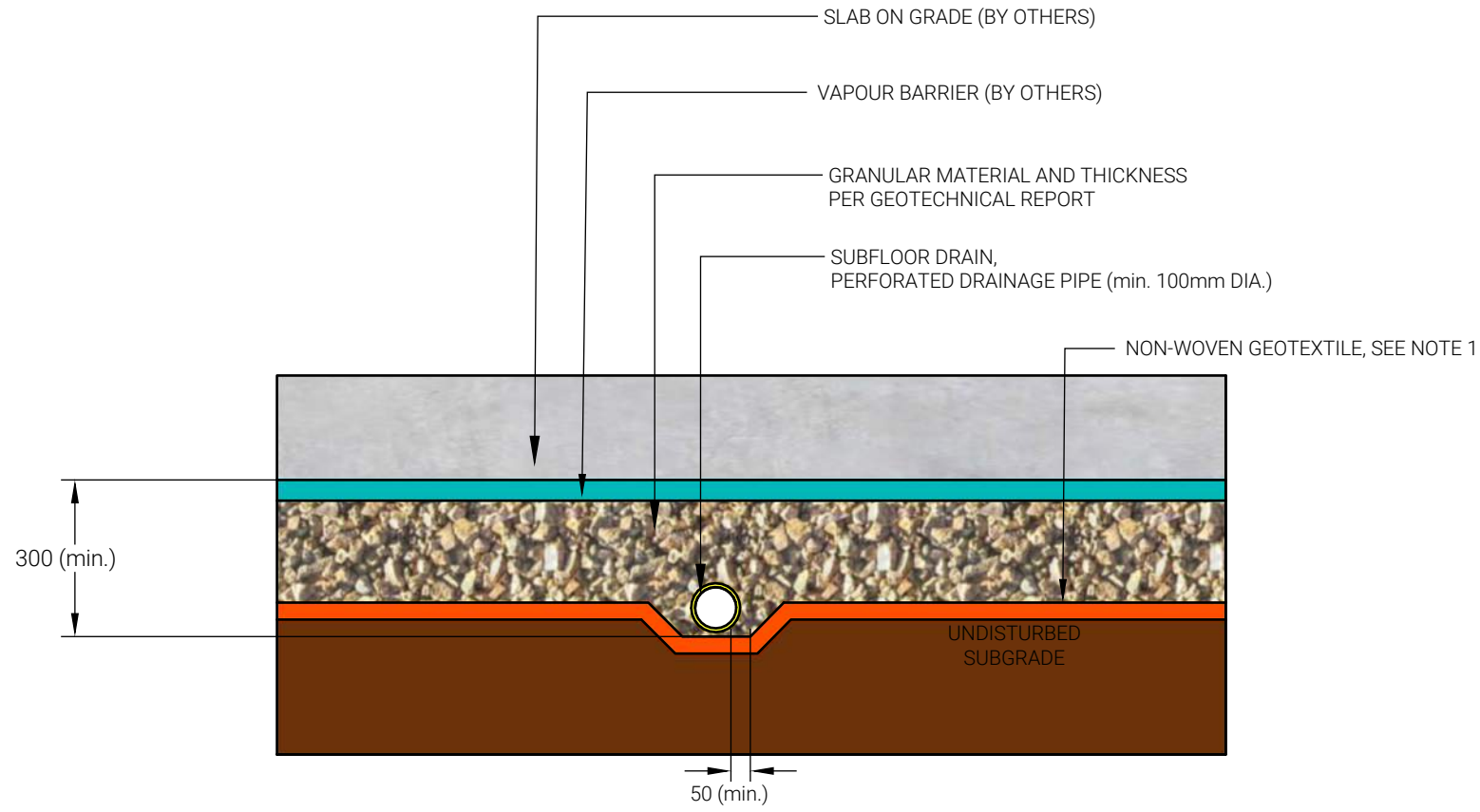

SECTIONAL VIEW

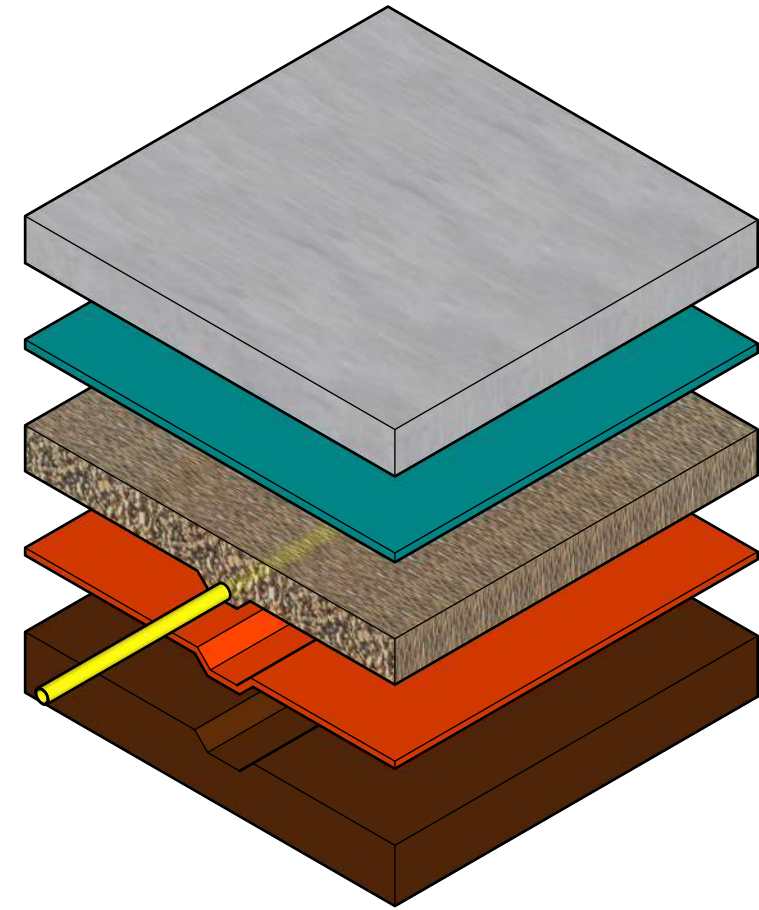

ISOMETRIC VIEW

NOTES

- 1. WHEN THE SUBGRADE CONSISTS OF COHESIONLESS SOIL, IT MUST BE SEPARATED FROM THE SUBFLOOR DRAINAGE LAYER USING A NON-WOVEN GEOTEXTILE (WITH AN APPARENT OPENING SIZE OF $< 0.250\text{mm}$ AND A TEAR RESISTANCE OF $> 200\text{ N}$).
- 2. TYPICAL SCHEMATIC ONLY. MUST BE READ IN CONJUNCTION WITH GEOTECHNICAL REPORT.

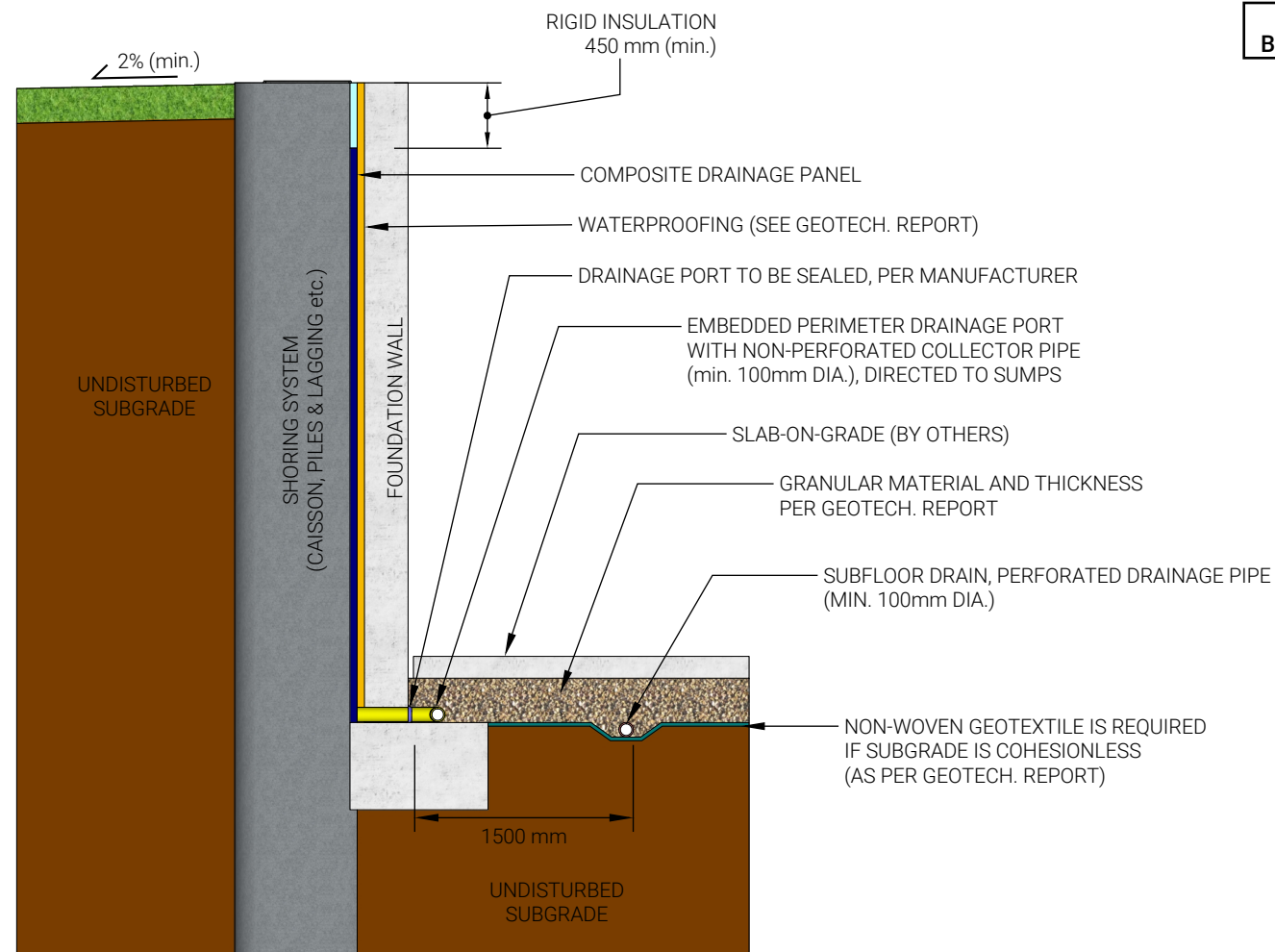

OBJECTS ARE COLOR-CODED BETWEEN TWO VIEWS FOR CLARITY

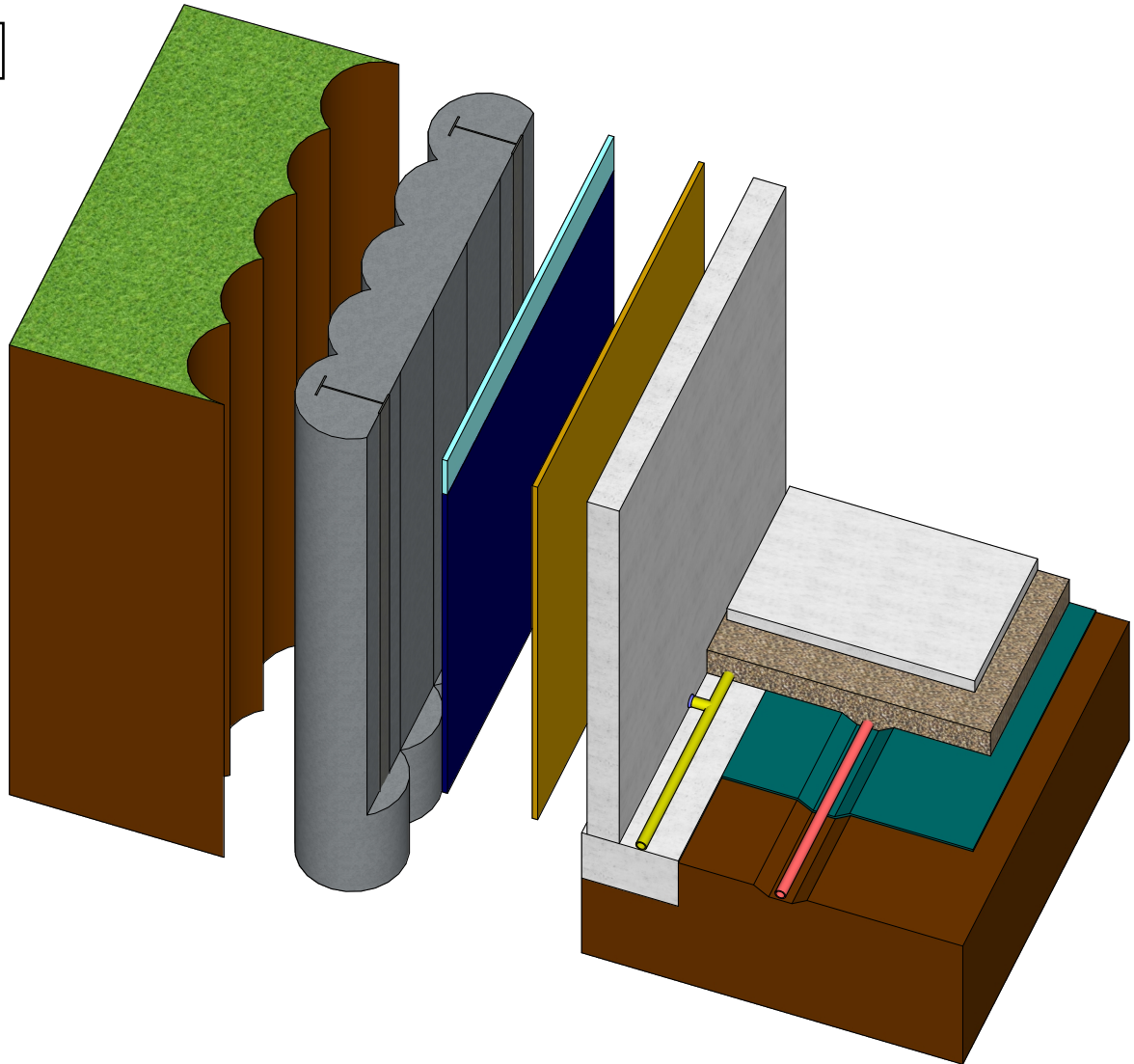

SECTIONAL VIEW

ISOMETRIC VIEW

SUBFLOOR DRAINAGE SYSTEM

1. THE SUBFLOOR DRAINS SHOULD BE SET IN PARALLEL ROWS, IN ONE DIRECTION, AND SPACED AS PER THE GEOTECHNICAL REPORT.
2. THE INVERT OF THE PIPES SHOULD BE A MINIMUM OF 300mm BELOW THE UNDERSIDE OF THE SLAB-ON-GRADE.
3. A CAPILLARY MOISTURE BARRIER (I.E. DRAINAGE LAYER) CONSISTING OF A MINIMUM 200 mm LAYER OF CLEAR STONE (OPSS MUNI 1004) COMPACTED TO A DENSE STATE (OR AS PER THE GEOTECHNICAL REPORT). WHERE VEHICULAR TRAFFIC IS REQUIRED, THE UPPER 50 mm OF THE CAPILLARY MOISTURE BARRIER MAY BE REPLACED WITH GRANULAR A (OPSS MUNI 1010) COMPACTED TO A MINIMUM 98% SPMDD.
4. A NON-WOVEN GEOTEXTILE MUST SEPARATE THE SUBGRADE FROM THE SUBFLOOR DRAINAGE LAYER IF THE SUBGRADE IS COHESIONLESS. THE NON-WOVEN GEOTEXTILE MAY CONSIST OF TERRAFIX 360R OR AN APPROVED EQUIVALENT.

PERIMETER DRAINAGE SYSTEM

1. FOR A DISTANCE OF 1.2m FROM THE BUILDING, THE GROUND SURFACE SHOULD HAVE A MINIMUM 2% GRADE.
2. PREFABRICATED COMPOSITE DRAINAGE PANEL (CONTINUOUS COVER, AS PER MANUFACTURER'S REQUIREMENTS) IS RECOMMENDED BETWEEN THE BASEMENT WALL AND RIGID SHORING WALL. THE DRAINAGE PANEL MAY CONSIST OF MIRADRAIN 6000 OR AN APPROVED EQUIVALENT.
3. PERIMETER DRAINAGE IS TO BE COLLECTED IN NON-PERFORATED PIPES AND CONVEYED DIRECTLY TO THE BUILDING SUMPS.
4. PERIMETER DRAINAGE PORTS SHOULD BE SPACED A MAXIMUM 3m ON-CENTRE. EACH PORT SHOULD HAVE A MINIMUM CROSS-SECTIONAL AREA OF 1500 mm².

GENERAL NOTES

1. THERE SHOULD BE NO STRUCTURAL CONNECTION BETWEEN THE SLAB-ON-GRADE AND THE FOUNDATION WALL OR FOOTING.
2. THERE SHOULD BE NO CONNECTION BETWEEN THE SUBFLOOR AND PERIMETER DRAINAGE SYSTEMS.
3. THIS IS ONLY A TYPICAL BASEMENT DRAINAGE DETAIL. THE GEOTECHNICAL REPORT SHOULD BE CONSULTED FOR SITE SPECIFIC RECOMMENDATIONS.
4. THE FINAL BASEMENT DRAINAGE DESIGN SHOULD BE REVIEWED BY THE GEOTECHNICAL ENGINEER TO CONFIRM THE DESIGN IS ACCEPTABLE.

Title



BASEMENT DRAINAGE SHORING SYSTEM TYPICAL DETAILS

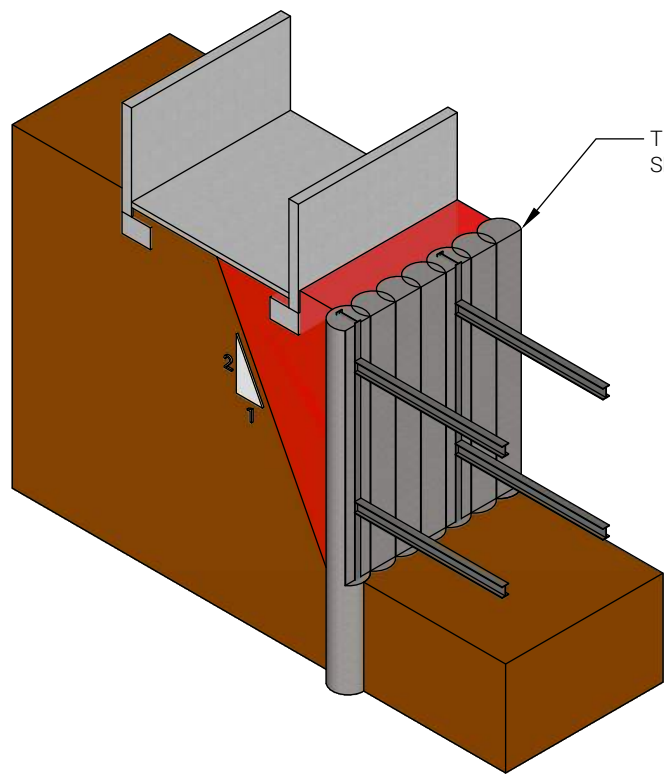

ZONE A (RED)

FOUNDATIONS WITHIN THIS ZONE OFTEN REQUIRE UNDERPINNING OR SHORING SYSTEM. HORIZONTAL AND VERTICAL PRESSURES ON EXCAVATION WALL OF NON-UNDERPINNED FOUNDATION MUST BE CONSIDERED

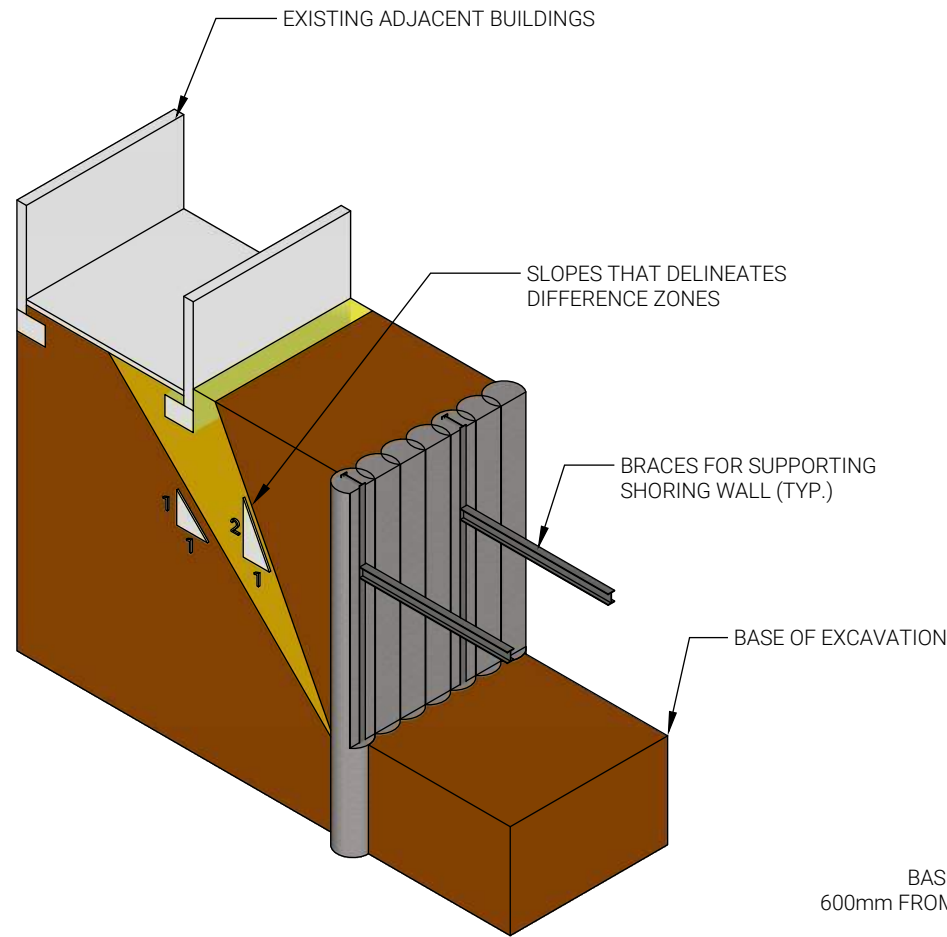

ZONE B (YELLOW)

FOUNDATIONS WITHIN THIS ZONE OFTEN DO NOT REQUIRE UNDERPINNING BUT MAY REQUIRE SHORING SYSTEM. HORIZONTAL AND VERTICAL PRESSURES ON EXCAVATION WALL OF NON-UNDERPINNED FOUNDATION MUST BE CONSIDERED

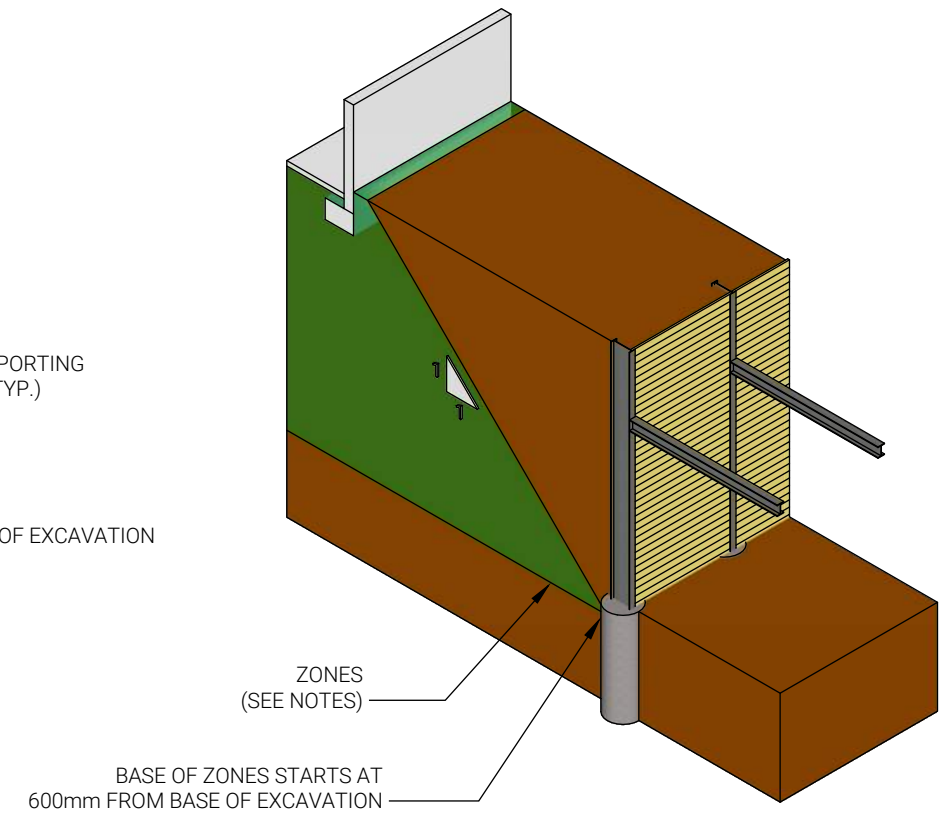

ZONE C (GREEN)

FOUNDATIONS WITHIN THIS ZONE USUALLY DO NOT REQUIRE UNDERPINNING OR SHORING SYSTEM

NOTES:

1. USER'S GUIDE - NBC 2005 STRUCTURAL COMMENTARIES (PART 4 OF DIVISION B) - COMMENTARY K.

Title